

Full-Duplex Communication in Cognitive Radio Networks: A Survey

Muhammad Amjad, Fayaz Akhtar, Mubashir Husain Rehmani, *Senior Member, IEEE*,
Martin Reisslein, *Fellow, IEEE*, and Tariq Umer, *Senior Member, IEEE*

Abstract—Wireless networks with their ubiquitous applications have become an indispensable part of our daily lives. Wireless networks demand more and more spectral resources to support the ever increasing numbers of users. According to network engineers, the current spectrum crunch can be addressed with the introduction of cognitive radio networks (CRNs). In half-duplex (HD) CRNs, the secondary users (SUs) can either only sense the spectrum or transmit at a given time. This HD operation limits the SU throughput, because the SUs cannot transmit during the spectrum sensing. However, with the advances in self-interference suppression (SIS), full-duplex (FD) CRNs allow for simultaneous spectrum sensing and transmission on a given channel. This FD operation increases the throughput and reduces collisions as compared with HD-CRNs. In this paper, we present a comprehensive survey of FD-CRN communications. We cover the supporting network architectures and the various transmit and receive antenna designs. We classify the different SIS approaches in FD-CRNs. We survey the spectrum sensing approaches and security requirements for FD-CRNs. We also survey major advances in FD medium access control protocols as well as open issues, challenges, and future research directions to support the FD operation in CRNs.

Index Terms—Cognitive radio network (CRN), full-duplex (FD) communication, spectrum sensing, self-interference suppression (SIS).

I. INTRODUCTION

THE ADVANCES in information and communications technologies over the past decade have enabled seamless connectivity among several entities and electronic devices. In order to keep up with this progress and enhance the consumer experience, service providers have started to introduce next-generation data-intensive applications. At the same time, a massive increase in the global subscription of wireless services, such as broadband, cellular, television, and navigation, is under way. Overall, there is an ever-increasing demand for uninterrupted ubiquitous connectivity and higher data rates. It has been predicted that by 2019, the global wireless data traffic will see a tenfold increase compared to the traffic in 2014 [1].

Manuscript received January 9, 2017; accepted June 8, 2017. Date of publication June 22, 2017; date of current version November 21, 2017. (Corresponding author: Martin Reisslein.)

M. Amjad, F. Akhtar, M. H. Rehmani, and T. Umer are with the COMSATS Institute of Information Technology, Wah Cantt 47040, Pakistan (e-mail: amjadbhutta0706@gmail.com; fayazakhtar@gmail.com; mshrehmani@gmail.com; t_umer@yahoo.com).

M. Reisslein is with the School of Electrical, Computer, and Energy Engineering, Arizona State University, Tempe, AZ 85287-5706 USA (e-mail: reisslein@asu.edu).

Digital Object Identifier 10.1109/COMST.2017.2718618

This exceptional growth has motivated the development of next generation wireless technologies, such as femtocells [2], [3], exploitation of millimeter wave spectrum [4], multiple-input multiple-output (MIMO) systems [5], [6], and dynamic spectrum sharing using cognitive radio (CR) [7]–[9].

A. Motivation: Need for Full-Duplex Communication in CRN

The rapid proliferation of wireless devices and data traffic has spurred the misconception that the wireless spectrum is becoming a scarce commodity. Spectrum usage analyses have revealed that large portions of the spectrum are not efficiently utilized [10]. Cognitive radio (CR) has garnered significant attention from academia and industry as a promising technique for enhancing the efficiency of spectrum utilization. CR replaces the inefficient traditional static spectrum management policies with dynamic spectrum access strategies. The dynamic spectrum access strategies allow for the opportunistic exploitation of the white spaces [11], [12], i.e., the unused or underutilized spectral resources.

Similar to traditional wireless networks, most existing CR networks (CRNs) employ half-duplex (HD) radios for the exploitation of white spaces. These HD-CR devices have two critical drawbacks. First, HD-CRN devices cannot simultaneously sense and access the spectrum. Hence, they typically employ a time-slotted two-stage white space exploitation process. This process senses the spectrum in the first stage and then communicates the data in the second stage. Spectrum sensing enables CRs to detect white spaces, therefore, imperfect sensing can result in data loss and harmful interference to primary users (PUs). Thus, HD-CR users usually sacrifice a significant portion of time for robust spectrum sensing, leaving only a modest part of the time for data communication. Furthermore, even after performing robust sensing, there is still a chance of affecting PUs as HD-CR users cannot detect PU transmissions during the transmission stage.

Second, HD-CR devices utilize two separate/orthogonal channels for data transmission and reception. This two-channel operation not only requires more precious spectral resources than single-channel operation, but also increases latencies as two channels need to be sensed for white space exploitation.

These constraints can be significantly mitigated by replacing HD radios with full-duplex (FD) systems [13]–[17]. FD systems enable simultaneous spectrum sensing and access

(transmission) as well as simultaneous data transmission and reception over the same idle channel during a given time period. Thus, FD-CR users can minimize data loss and do not need to interrupt their transmissions for channel sensing. Hence, FD-CR improves the spectrum utilization and in the process, increases the overall network capacity. These FD advantages are achieved at the expense of increased energy consumption and increased hardware complexity. Despite the beneficial traits of FD communication, for several years, the actual realization of FD systems was considered impractical due to self-interference (SI), i.e., due to the narrow gap (spacing) between the transmission and reception antennas. Simultaneous data transfer and reception can result in transmitted signals being looped back to the receiving antennas [13]. However, recent pragmatic developments in SI suppression/cancellation techniques [15] and the use of a single antenna [18] for achieving FD communications has shown great promise for realizing FD communications in future wireless networks.

Full-duplex cognitive radio networks (FD-CRNs) can improve a wide range of existing and future applications of CRNs. FD-CRNs can be exploited in some unique centralized and decentralized CRN scenarios [19], [20]. In a distributed scenario without a central entity for allocating resources to CR users, each CR user must itself identify viable white spaces. In case of HD-CR, a new CR user can collide with licensed recipients as well as with incumbent CR users. In contrast, FD-MIMO systems, with separate antennas for sensing, transmission, and reception, can support bidirectional communication while sensing, thus greatly reducing collisions. In centralized networks, FD-CR access points can help identify white spaces in real time for the associated CR network users. Thus, CR users can concentrate on data communication which reduces their power consumption and SI interference among sensing antennas. In fact, a single antenna can be used for achieving FD communication in such a centralized environment [18]. Furthermore, access points can act as relays for forwarding data in real time using multiple antennas all the while not affecting the licensed PUs.

Since the integration of FD technology in CRNs enables the exploration of another dimension of increasing spectrum utilization and network capacity, FD-CR technology requires new designs of network architectures and protocols. The high potential of FD technology in CRNs has so far inspired rapid research developments, which we survey and characterize so as to take stock of the accomplishments to date and to highlight open research issues and challenges to enable further wireless innovation.

B. Contributions of This Survey Article

While a few overview articles have outlined some selected aspects of FD-CRNs, to the best of our knowledge, there is no prior comprehensive survey on this topic. In this paper, we provide a comprehensive survey of FD-CRNs. In summary, we make the following contributions:

- We provide an in-depth discussion of existing FD-CRN architectures and related case studies as well as radio

requirements and antenna designs for FD-CRNs communications.

- We survey the various self-interference suppression (SIS) approaches for FD-CRNs.
- We survey spectrum sensing mechanisms and identify the operation of various medium access control (MAC) protocols for FD-CRNs.
- We survey security and privacy issues in FD-CRNs.
- We outline open issues, challenges, and future research directions for FD-CRNs.

C. Review of Related Survey Articles

Our present survey on FD communication in the context of CRNs is different from previous magazine articles and surveys as we comprehensively cover the area of FD-based CRNs. There is an extensive literature of prior surveys that focus on CRNs. Also, some recent surveys discuss FD communication in the context of conventional networks. There are also some magazine style articles on FD-CRNs. However, to the best of our knowledge, there is no prior detailed survey that comprehensively covers the incorporation of FD technology in CRNs.

There is an extensive survey literature on CRNs [10]. Surveys focused on spectrum sensing, sharing, and occupancy in CRNs have appeared in [21]–[45]. CRN routing protocols have been presented in [46]–[48], while white spaces have been explored in [11], [12], and [49]. Surveys on MAC protocols for CRNs are provided in [50] and [51], while the security, privacy, and threats of CRNs have been surveyed in [52]–[58]. CRN radio resource allocation has been discussed in [59]–[61], and green energy-powered CRNs have been presented in [60] and [62]. CRNs have also recently been examined in the contexts of machine learning [63], [64] and artificial intelligence [65]. Standardizations work on CRNs has been presented in [66]–[70].

A brief survey on FD relaying with focus on 5G applications has been presented in [71]. The discussion in [71] covers fundamental relaying concepts, SI cancellation techniques, relaying protocols, and performance analysis of FD schemes. Detailed general surveys focused on in-band FD communication [13], [15] have considered the physical and MAC layer perspectives, as well as, the FD relaying approach. The possibility of integrating FD in CRNs has been briefly mentioned in [13] and [15]. Another comprehensive FD communications survey has been presented in [72]. Similar to the other surveys, [72] discusses the fundamental benefits of employing FD and the SI issues involved in FD communication. Moreover, design challenges for practical FD systems and applications have been presented in [72], along with a sporadic discussion on how FD can be incorporated in CRNs.

The recent brief article [19] pioneered the survey of FD-CRNs by giving a brief overview of FD communication in the context of overlay CRNs (see Section II-A4). The article [19] discussed the novel FD specific Listen And Talk (LAT) protocol [73] for CRNs and compared it with the conventional HD Listen Before Talk (LBT) protocol. Furthermore, the

TABLE I
LIST OF ACRONYMS AND CORRESPONDING DEFINITIONS

Acronyms	Definitions
ADC	Analog-to-Digital Converter
AF	Amplify and Forward
ALC	Analog Linear Cancellation
BER	Bit Error Rate
BS	Base Station
CR	Cognitive Radio
CRNs	Cognitive Radio Networks
CRANs	Cloud Radio Access Networks
CSMA	Carrier Sense Multiple Access
CSS	Cooperative Spectrum Sensing
CW	Continuous Wave
D2D	Device to Device Communications
DLC	Digital Linear Cancellation
DSA	Dynamic Spectrum Access
EGC	Equal Gain Combining
HD	Half-Duplex
HDR	Half-Duplex Relay
INR	Interference Signal to Noise Ratio
LAT	Listen-and-Talk
LBT	Listen-Before-Talk
MIMO	Multiple-Input and Multiple-Output
MRA	Multi-Configurable Antennas
MSE	Mean-Squared Errors
MU-MIMO	Multiuser-MIMO
NOMA	Non-Orthogonal Multiple Access
OSA	Opportunistic Spectrum Access
PIC	Photonic Integrated Circuit
PID	Proportional Integral Derivative
PLR	Packet Loss Ratio
PU	Primary Users
RF	Radio Frequency
SBS	Secondary Base Station
SE	Spectrum Efficiency
SI	Self-Interference
SIP	Self-Interference Pricing
SIS	Self-Interference Suppression
TDTB	Time Domain-Transmit Beamforming
TRAPS	Transmit-Receive Antenna Pair Selection
UE	User Equipment
USRP	Universal Software Radio Peripheral
ZFBB	Zero-Forcing Beamforming

use of FD in some centralized and distributed CRN scenarios was presented, along with a number of research challenges. Complementary to [19], this survey gives a comprehensive up-to-date review of FD-CRNs, including supporting architectures and antenna designs, spectrum sensing mechanisms, SI mitigation schemes, and MAC protocols, as well as security and privacy issues. We also outline emerging applications and detail current challenges and future research directions.

D. Article Structure

A list of acronyms used throughout the paper is presented in Table I. The rest of the paper is organized as follows: Section II provides an overview of CRNs and FD communication, while Section III outlines illustrative case studies on the operation of FD-CRNs. Section IV highlights the various architectures that involve FD-CRNs. Radio requirements and antenna designs for FD-CRNs are presented in Section V. Section VI surveys the main SIS approaches. Section VII surveys spectrum sensing approaches for FD-CRNs, while MAC protocols are surveyed in Section VIII. Section IX outlines the work on security in

FD-CRNs. Standardization, simulation tools, prototype, and supportive hardware platforms for FD-CRNs are surveyed in Section X. We outline open issues, challenges, and future research directions in Section XI. Section XII concludes this article.

II. COGNITIVE RADIO (CR) AND FULL-DUPLEX (FD) COMMUNICATION: AN OVERVIEW

A. Cognitive Radio Networks (CRNs)

1) *Licensed and Unlicensed Frequency Bands*: The wireless radio spectrum is exploited by a wide range of applications and is separated into chunks of frequency bands ranging from 9 KHz to 3 THz. These bands can be classified into licensed and unlicensed frequency bands. Licensed bands require a licensing fee before they can be utilized. Licensing grants exclusive rights to specific sets of frequency bands and ensures that there is no interference from other wireless entities. The unlicensed frequency bands have internationally been excluded from sale (licensing) and are usually utilized for low-cost communication. However, a key trade-off is that they are vulnerable to interference due to the limited number of unlicensed bands and the large user base competing for bandwidth in these bands. National regulatory authorities auction the licensed bands by following the conventional static spectrum management policies. The static policies allocate fixed spectral bands to license holders on a long term basis for large geographical regions. Measurements indicate that conventional static policies lead to spectrum utilization levels varying between 15 % to 85 % [10], thus giving rise to white spaces, i.e., unused and underutilized spectral resources.

2) *Dynamic Spectrum Access*: A promising solution for exploiting these white spaces is to employ Dynamic Spectrum Access (DSA) [74], the enabling technology of CR [7], [75]. Using DSA strategies, CR devices can identify viable white spaces and reconfigure their communication parameters so as to opportunistically exploit the white space without interfering with the licensed users. A CRN has two types of users: primary user (PUs) and CR users (also referred to as secondary users (SUs)). PUs are licensed users that have paid royalty fees to obtain exclusive rights to operate in a prescribed set of licensed frequency bands without any sort of interference. On the other hand, CR users are unlicensed users without a spectrum license. CR users employ CR technologies to opportunistically access the white spaces without causing harmful interference to PUs. CR users can operate on both licensed and unlicensed bands. However, unlike in licensed bands, in unlicensed bands, CR users are not required to identify the white spaces and usually follow a greedy spectrum access approach, i.e., the CR users utilize spectral resources whenever required without consideration of ambient users.

3) *White Space Exploitation Cycle*: CR systems typically follow a four stage white space exploitation cycle including: 1) Spectrum sensing, i.e., identification of white spaces by sensing the spectral bands; 2) Spectrum decision which is the selection of the best available channels based on several diverse parameters [21]; 3) Spectrum mobility ensures seamless connectivity if the specific spectral resources in use

are required by a PU, then the channel must be vacated and communication must continue in another vacant white space portion; finally, 4) Spectrum sharing which coordinates spectrum access by multiple CR users in order to avoid collisions.

4) *White Space Utilization Paradigms*: CR based networks are typically classified into three main paradigms: The conventional interweave paradigm involves opportunistic white space exploitation in time, frequency, or space (geographic location) when PUs are idle. In the underlay paradigm, CR users transmit on licensed bands using low-power devices with a limited range, PUs and CR users can transmit simultaneously as long as the interference to PUs is within acceptable limits. In the overlay paradigm, CR users transmit simultaneously with PUs on licensed frequency bands by detecting the presence of PUs and appropriately changing the characteristics of the CR transmitted signal to avoid interference with PUs. Depending on the paradigm, CR systems may follow all or specific stages of the white space exploitation cycle.

Apart from cellular networks, CR communication has several emerging applications in a diverse range of domains [76], including CR-based smart grids [69], [77], cognitive radio sensor networks [78], and CR technology in unmanned aerial vehicles [79].

B. Full-Duplex (FD) Communication

1) *Half-Duplex vs. Full-Duplex Communication*: The term “duplex” in a wireless network refers to the ability of two systems to communicate with each other, i.e., both systems are capable of data transmission and reception. However, whether the communication can be done simultaneously or not, depends on the systems’ data flow capability, i.e., Half-Duplex (HD) or Full-Duplex (FD). Due to its implementation simplicity, HD is the most commonly used data flow mode in wireless networks. HD enabled systems cannot transmit and receive simultaneously. Thus, in HD-CRNs the spectrum sensing and transmission cannot be conducted simultaneously; therefore, typically half of the time is used for spectrum sensing and the other half of the time is used for transmission, reducing throughput compared to FD systems. HD systems also lead to the inefficient utilization of spectral resources, i.e., orthogonal spectral resources need to be allocated for transmission and reception if the systems should transmit and receive simultaneously. For example, most mobile networks employ two sets of frequencies for uplink and downlink transmissions. Furthermore, HD systems are prone to hidden and exposed terminal problems [80].

Advanced wireless communication systems can support high data rates. For example, as compared to 4G wireless networks, 5G wireless networks may provide a thousand fold (1000x) higher data rate. This increase in data rate is due to network densification, femtocell deployments, and mmWave communications [4], [71], [81]. For spectrum efficiency, various non-orthogonal transmission modes are integrated into advanced wireless communication systems. Among the non-orthogonal approaches, non-orthogonal multiple access (NOMA) [82], [83], non-orthogonal filter

bank multi carrier (FBMC) [81], [84], and full-duplex communication [13]–[15] have been introduced to enhance the network capacity and to efficiently utilize the spectrum resources. The non-orthogonal components of NOMA and FBMC induce relatively high self-interference (SI) compared to FD communication. Self-interference suppression (SIS) can be more easily achieved in FD communication compared to NOMA and FBMC. Hence, FD communication has found a wide range of applicability as compared to NOMA and FBMC.

A two fold increase in the ergodic capacity has been witnessed when using FD communication [13]. FD is not a new idea, a continuous wave (CW) radar systems first used FD communication in 1940 to enhance the network capacity and to efficiently utilize the spectrum resources [13]. While using the existing resources, it was generally believed that a single radio could not send and receive information simultaneously [85]. However, this restriction has been invalidated with the advent of FD communication. By employing FD communication, a single radio can send and receive messages at the same time over the same frequency band. FD communication, i.e., using a single channel for transmission and reception at the same time, usually demands only half the spectral resources as compared to HD communication [86].

FD communication can be achieved by using separate transmit and receive antenna pairs, by exploiting a shared transceiver architecture, by employing relaying topologies, and by using multiple spatial streams, such as MIMO and SISO (see Section V-A4) [15]. In a shared transceiver, the transmitted and received signals are separated using a duplexer which routes each of the signals to their respective functions [87].

2) *Network Topologies*: FD enabled centralized and distributed networks can be classified into three main topologies: In the conventional bidirectional topology, two FD systems transmit and receive simultaneously, thereby minimizing delay and doubling spectral efficiency (compared to two HD systems that utilize orthogonal time slots for data transmission and reception). In the relay topology [88], [89], FD data relaying systems can simultaneously receive and forward data in real time on a common carrier. In the Base Station (BS) topology, the FD enabled BS supports simultaneous uplink and downlink data communication on a common carrier (compared to an HD environment, where the BS alternates between orthogonal uplink and downlink carriers). In each topology, the systems can be equipped with multiple antennas and the number of antennas per system can differ. Table II summarizes the comparison of HD-CRNs and FD-CRNs.

C. Motivation for Employing Cognitive Radios (CRs) With Full-Duplex (FD) Mode

In HD-CRNs, each time slot of the SUs is divided into two sections (portions). In the first portion, the SUs sense the available spectrum. In the second portion, the SUs transmit the data. However, this approach has two limitations: First, during the sensing of available spectrum, the transmission of data is interrupted even with the availability of long and continuous spectrum white space. Second, during the transmission of data, the sensing of the spectrum is halted which can risk interference to the PUs. These limitations have resulted in the

TABLE II
SUMMARY COMPARISON OF HALF-DUPLEX (HD) COGNITIVE RADIO NETWORKS (CRNs) AND FULL-DUPLEX (FD) CRNs

Parameter	HD-CRNs	FD-CRNs
Self-Interference Suppression (SIS)	N/A	Passive and Active SIS approaches are used in FD-CRNs to suppress the SI at the local input transmitter
Spectrum Sensing	Spectrum sensing is not continuous. A pre-defined spectrum sensing duration is used	Spectrum sensing is continuous; there is no prescribed spectrum sensing duration
Spatial Correlation	There exists a trade-off between spatial correlation and throughput	The spatial correlation does not exist in FD-CRNs
Secondary Transmit Power	The throughput increases with increasing power	There exists a trade-off between throughput and power
PR Activity	Monitors the PUs with different models, as discussed in [40]	With continuous spectrum sensing, monitoring the PUs activity becomes more reliable
Security	Security is a serious concern with a wide range of security threats	With the FD capability, anti-jamming antennas can counter the impact of various eavesdroppers
Standards	Well-defined HD-CRN standards exist	Requires extensive standardization work
Communication Protocols	Considerable work has been done on communication protocols	The major focus has so far only been on FD capable MAC protocols
Simulation Tools	Extensive simulation tools are available to evaluate HD-CRN performance	Very limited simulation tools are available that can consider SIS approaches

emergence of FD-CRNs, where SUs sense the available spectrum and transmit data simultaneously. In the following we summarize the main motivations for the provisioning of FD capabilities in CRNs:

- In HD-CRNs, SUs cannot detect PU activity during data transmissions. This can result in interference to the PUs. In contrast, in FD-CRNs, simultaneous sensing and transmission minimize the interference for PUs [90]. In FD-CRNs, the PUs activity can be continuously monitored, minimizing any possibilities for interference to PUs.
- In FD-CRNs, the sensing of the available white space is continuous during the transmission of data. This continuous white space sensing improves spectral efficiency. The FD-enabled CR users can find more white spaces and thus experience improved sensing performance compared to HD-CRNs.
- In FD-CRNs, the transmission of data is continuous and is not interrupted by the sensing operation (in contrast, in HD-CRNs, the sensing interrupts data transmission). The continuous data transmissions result in improved data rates for SUs.
- During transmission, collisions between SUs in HD-CRNs can greatly reduce the system performance. The collision duration can be large as the collision detection during the transmission may be interrupted [91], [92]. With the provisioning of FD capability in CRNs, the collision probability can be reduced without interrupting the transmission of the data.
- Security is an important concern in CRNs. Eavesdroppers in the form of PUs can undermine the privacy of SUs. However, in FD-CRNs, anti-jamming signals can be continuously produced without disturbing the transmission cycle. In cases, where multiple antennas are employed in FD-CRNs, an antenna can be assigned to the task of transmitting the anti-jamming signals, that can overcome the impact of eavesdroppers.
- Energy-efficiency is also an important concern for wireless communication. In order to harvest energy from an external source, SUs in HD-CRNs have to suspend

their transmission and sensing operations. However, in FD-CRNs, the full-duplex SUs (FD-SUs) can harvest energy [93] without interrupting the spectrum sensing and transmission of data.

- FD-CRNs have witnessed an increased throughput compared to HD-CRNs. FD-CRNs in conjunction with advanced network technologies, such as 5G, can fulfill the needs for spectrum efficiency and enhanced data rates for data-intensive applications, such as multimedia.

D. Unique Challenges of Full-Duplex Cognitive Radio Networks (FD-CRNs)

Although the vision of FD communication in wireless networks has been around for several decades, FD communications has yet to be fully exploited. This is because FD communication is fraught with several unique challenges that have severely restricted its practical utilization. We proceed to summarize the main challenges faced by FD-CRNs:

1) *Self-Interference*: Usually, the signal leakage from the local sender to the local receiver results in self-interference (SI) [19]. If the SI is not properly suppressed in FD communication, the SI can reduce the FD system performance below that of HD communication. The theoretical doubling of the throughput with FD communication can only be achieved when the SI power level is kept low compared to the noise level. Therefore, effective SIS approaches should be used to gain the two fold increase in the system throughput. Various SIS approaches have been introduced that can passively or actively mitigate the SI in FD-CRNs. Of these approaches, the wireless-propagation-domain [99]–[102], the analog-circuit-domain [103], and the digital-circuit-domain [14], [104], [105], or combinations of all these domains can be employed [87], [106], see Section VI. SIS approaches prevent oscillations in the receiver and enhance the reliability and stability of FD-CRNs.

2) *Hardware Imperfections*: Hardware imperfections in CRNs [107], such as non-linear distortions, phase noise, non-ideal frequency responses of circuits, power amplifier nonlinearities, as well as in-phase and quadrature phase (I/Q)

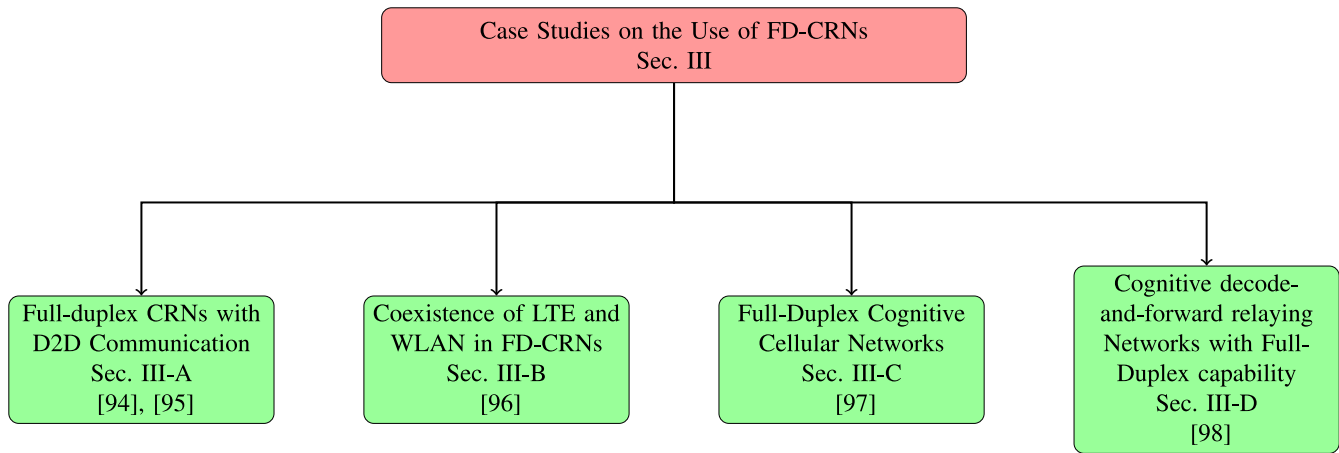

Fig. 1. Case studies on the use of FD-CRNs in the contexts of D2D communications, WLANs, cellular networks, and relay networks.

imbalances, not only degrade the system performance but also degrade the performance of SIS approaches [72], [108]. Also, in wireless communication, optimal feedback information from the receiver is usually instrumental for improving the system gain. However, due to the simultaneous sending and receiving of data in FD communications by the sender and receiver, only limited feedback information is communicated. Moreover, the limited dynamic receiver range and the noise in the local oscillator reduce the effectiveness of SI mitigation schemes in FD communication. The limited dynamic range at the receiver results in quantization errors that are usually overcome with the help of precoding schemes in FD communication system [13].

3) *Resource Allocation*: The allocation of resources (especially the radio resources) is a challenging task in the design of reliable FD-CRNs. FD-CRNs with more than two antennas and SIS approaches demand more power compared to conventional HD systems. Increased power levels can result in high SI and inter-user interference. However, minimizing the power levels may degrade the throughput. Therefore, not only the power, but also the other resources should be optimally allocated to FD-CRN enabled devices [109].

4) *Redesign of Communication Protocols*: FD-CRNs demand the redesign of various physical layer mechanisms as well as MAC and other communication protocols. MAC layer problems, such as hidden terminals, congestion, as well as packet losses and delays, and network layer issues, such as spatial reuse and asynchronous contention, demand extra considerations when using the FD capability [105].

5) *Spectrum Sensing*: Compared to HD-CRNs, the spectrum sensing in FD-CRNs is continuous and is not interrupted by data transmissions. Therefore, the spectrum sensing approaches for FD-CRNs should be redesigned according to continuous sensing opportunities and requirements.

III. CASE STUDIES ON THE USE OF CR WITH FULL-DUPLEX

In this section, we briefly review five case studies (see Figure 1), that illustrate the operation of FD-CRNs. We have selected these five case studies from the literature to showcase

FD-CRN operation in unique and distinct network structures, such as D2D communications, cellular networks, WLANs, and relay networks. These case studies are meant to illustrate how CRs with FD have been used in different CR-based networks and that FD-CRNs have a vast application range in different CR-based networks.

A. FD-CRNs for D2D Communications

In device-to-device (D2D) communication, FD-CRNs can increase the throughput and rate gain, i.e., improve the data rate achieved through utilizing the D2D links [94]. In the D2D case study [94], D2D communication links use full-duplex relaying (FDR) in a cognitive underlay manner (see Section II-A4). FDR shows better spectral efficiency compared to half-duplex relaying (HDR) [95]. The combination of D2D communication and cognitive FDR not only enhances the spectral efficiency but also the data rate. The optimal power allocation of the secondary transmitter and FDR help in mitigating the SI. This optimal power allocation also minimizes the outage probability and enhances the throughput. The performance studies in [94] indicate that D2D communication with FDR achieves improved performance compared to cognitive HDR.

B. FD-CRNs in WLAN Context

The case study [96], examined the co-existence of LTE in the unlicensed WLAN band with FD spectrum sensing capability. Cyclostationary spectrum sensing enhances the spectral efficiency of LTE while exploiting the unlicensed band. The SI is suppressed by employing analog and digital SIS approaches that also improve the detection probability.

C. FD-CRNs in Cellular Network Context

FD-CRN capabilities can increase the range, throughput, and spectral efficiency of cellular networks [97], [110]. A secondary base station (SBS) can simultaneously sense and transmit with only one channel. The optimal power is allocated to the SBS to overcome the interference at the SBS. Usually, the power-throughput tradeoff is achieved to gain

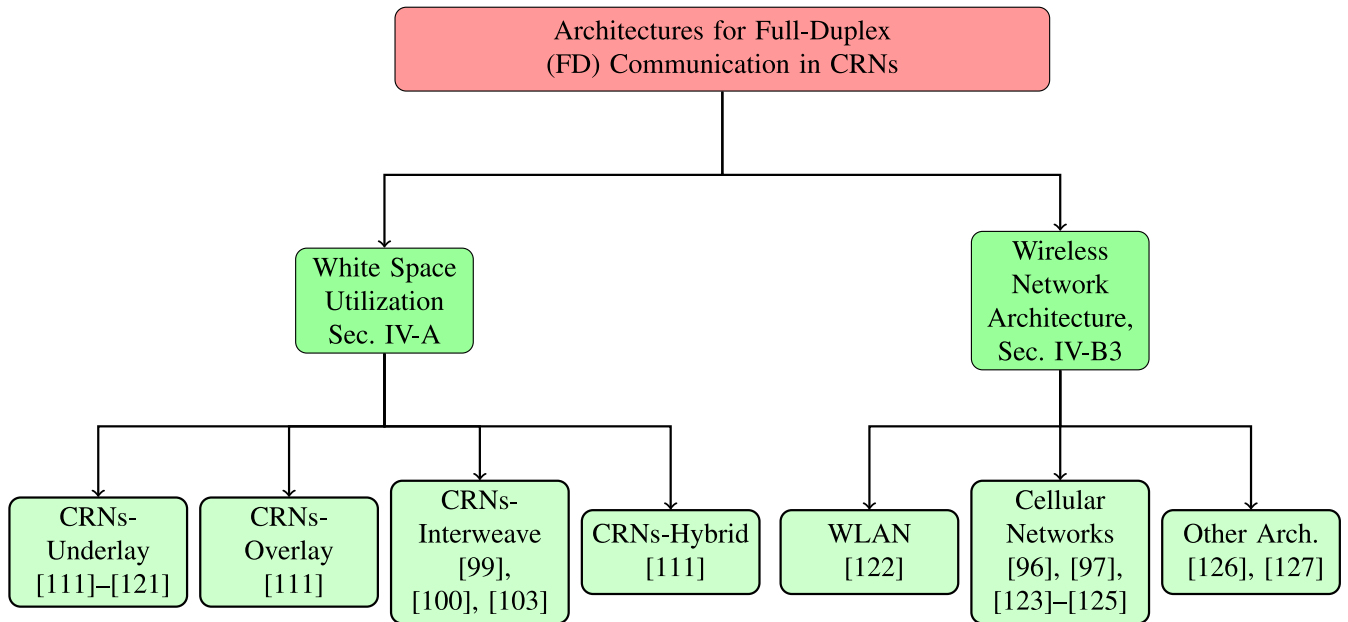

Fig. 2. Full-duplex (FD) communication can be used in the context of various cognitive radio network (CRN) architectures. We classify FD-CRN architectures according to the type of white space utilization and the type of wireless network architecture. The white space utilization types encompass underlay, overlay, interweave, and hybrid FD-CRNs. The wireless network architecture types encompass FD-CRNs based on underlying WLAN and cellular network architectures as well as other types of architectures.

the maximum throughput, while residing within the tolerable interference. The propagation-based SIS approach with a proper antenna separation is used to mitigate the self-interference and inter-cell interference.

D. FD-CRNs in Relay Network Context

The case study [98] examined how adaptive transmission modes can enhance the data rates in three transmission modes namely, HD, FD, and direct transmission. The power at the secondary transmitter is controlled by taking into consideration the interference at the PUs. The SI with FD operation is suppressed by modeling the SI as a fading channel. An outage analysis demonstrates the effectiveness of the proposed scheme compared to simple relaying networks.

E. Summary and Insights

In this section, we have summarized five case studies that integrate FD-CRN operation to achieve higher data rates and spectral efficiencies. While FD operation can theoretically double the throughput, the throughput increases achieved in practical systems are lower due to the SI. The summarized case studies include several communication scenarios, such as D2D communications with FD-CRNs. The D2D communication link uses an underlay FD link to efficiently use the spectrum [94]. The study on LTE-WLAN coexistence with FD-CRN techniques [96] uses cyclostationary spectrum sensing with active SIS. FD-cognitive cellular networks simultaneously sense and transmit with the help of a SBS [97]. The operation of FD cognitive relaying networks with a decode-and-forward (DF) approach has been highlighted in [98].

IV. CRN ARCHITECTURES SUPPORTING FULL-DUPLEX (FD) COMMUNICATION

This section surveys the existing cognitive radio network (CRN) architectures that can support full-duplex (FD) communication. The existing literature has approached the study of FD-CRN architectures from two main perspectives: One set of studies has approached the area from the perspective of the type of white space utilization, i.e., the white space utilization paradigm (see Section II-A4). We survey this set of studies, which are categorized into the left branch of Fig. 2, in Section IV-A. In particular, we sub-classify these studies according to the type of white space utilization into architectures with underlay, overlay, interweave, and hybrid white space utilization. The second set of studies has approached this area from the perspective of the architecture (or setting) of the considered underlying network. We categorize this set of studies into WLAN architectures, cellular network architectures, and other network architectures, see right branch of Fig. 2 and corresponding Section IV-B.

We note that an alternate classification of the architecture aspect of FD-CRNs could consider the topology of the FD communication, see Section II-B2. However, from our review of the literature, we found that a potential classification from the FD communication topology perspective is less intuitive and insightful than our adopted classification strategy. Our classification strategy starts from the by now relatively well established white space utilization paradigms (left branch of Fig. 2) and the conventional different network architecture settings (right branch of Fig. 2) to lead the reader through the respective resulting architectures that can support FD-CRN communication.

A. FD-CRN Architectures Classified by Type of White Space Utilization

In FD-CRNs, the SUs can simultaneously sense and transmit with the help of FD radios while using the same channel. From the perspective of white space utilization, CRNs can be classified into underlay, overlay, interweave, and hybrid CRNs [11] (see Section II-A4).

1) *Underlay White Space Utilization*: In CRNs with underlay white space utilization, SUs transmit with low power simultaneously with PUs on licensed bands [128]. SUs use the licensed channel while keeping the interference to PUs within the tolerable range. This type of channel utilization is also referred to as gray space utilization [11]. CRNs with underlay white space utilization have been studied in the context of FD communication. In particular, an FD-CRN with underlay white space utilization has been examined in [111]. In [111], the opportunistic spectrum access (OSA) of the gray space has been implemented with two antennas using a centralized architecture. SUs simultaneously sense and transmit with low power while using waveform-based spectrum sensing. Determining the power level that should be allocated for FD-CRNs while using the underlay approach is a complex problem.

This power level adjustment problem, that is specific to CRNs with underlay white space utilization, has been examined in [112] through a control theoretic approach. This control theoretic approach allocates optimal power levels in the FD-CRN so as to efficiently utilize the gray space. Increasing the power not only increases the interference to the PUs but also affects the throughput. Therefore, a power-throughput trade-off needs to be considered to optimally use underlay FD-CRNs [113]–[117].

The performance of the FD-CRNs with underlay white space utilization has been evaluated and compared with HD-CRNs in [118]. The SI and primary interference under various constraints of spectrum sharing have also been considered while evaluating the performance of FD underlay networks. The performance of FD-CRNs with the underlay approach with future needs has been studied in [119]. The spectrum sharing between PUs and SUs operating with the FD-CRN method has been analyzed. Clustered relaying is used with the underlay approach to estimate the future spectrum demands for FD-CRNs.

A single carrier approach to spectrum sharing in FD-CRNs with underlay white space utilization has been studied in [120]. In particular, a cyclic prefix single carrier is employed in a cooperative spectrum sharing approach to achieve high spectral efficiency. Multipath diversity gains have also been achieved in this cooperative underlay FD-CRN. Estimating the signal to noise ratios (SNRs) of the PUs is critical for underlay FD-CRNs. A PU SNR estimation approach has been presented in [121], through which the FD-SUs can estimate the primary link SNR while operating in the underlay mode.

2) *CRN Overlay White Space Utilization*: In overlay CRNs, the SUs transmit simultaneously with the PUs by adjusting their transmission characteristics to avoid SI with the PUs [11], [129]. An overlay approach with opportunistic

spectrum access (OSA) has been proposed in [111]. SUs with FD antennas simultaneously sense and transmit while the PUs use a centralized network approach. In this overlay architecture, the SU transmission power is kept low as compared to the PUs to minimize the SI and the interference to the PUs. The primary central base station helps the SUs in sensing the licensed channel while supporting both the underlay and overlay architecture. SI and the primary interference have been avoided by employing a hybrid approach for mitigating the interference. FD-CRNs with overlay white space utilization have only received very little research attention to date. There are plentiful opportunities for future research on overlay FD-CRNs.

3) *CRNs With Interweave White Space Utilization*: In interweave CRNs, the SUs can only transmit when the licensed band is idle. When the PUs become active, the SUs leave the channel to avoid interference [11]. The LAT protocol, which forms the basis of FD-CRNs, has been studied for an interweave FD-CRNs architecture in [100]. The performance of the proposed scheme has been mathematically analyzed as well as practically simulated with a propagation-based SIS approach. A specifically designed antenna separation approach suppresses the SI, thus SUs can simultaneously sense and access the spectrum holes for communication.

A first practical study of FD-CRNs using the interweave architecture of CRNs and FD radios has been carried out in [99]. In the initial stage, the system exhibited an increased SI. However, with the help of directional multi-configurable antennas (MRAs), the SI has been suppressed. The characterization of the transmission range and rate has demonstrated that the FD-CRN approach achieves higher performance than the HD-CRN approach. A photonic integrated circuit (PIC) has been designed in [103] to evaluate the FD behavior in CRNs. This PIC continuously monitors the dynamic environment with two antennas, performs sensing, and makes transmission decisions. An analog SIS approach (see Section VI-C2) is used to mitigate the SI in this PIC.

4) *FD CRNs With Hybrid White Space Utilization*: The FD capability in CRNs can also be achieved by using combinations of any two or more of the white space utilization paradigms. The maximum white space utilization can typically be achieved via hybrid structures [11]. A centralized FD-CRN topology with both the underlay and overlay network architecture has been implemented in [111]. However, to the best of our knowledge, very limited research has been conducted to date on the implementation of hybrid white space utilization in FD-CRNs. The study [130] has used the hybrid overlay/underlay architecture for maximum white space exploitation in HD-CRNs. This study can be extended with FD capability in CRNs to increase the performance of multiband FD-CRNs.

B. FD-CRNs Based on Different Network Architectures

1) *WLAN-Based FD-CRNs*: A wireless local area network (WLAN) encompasses a limited geographic area of approximately 30 meters [131]. CRN capabilities in WLANs can improve the scalability and spectrum efficiency [96], [132]. The integration of FD into WLANs,

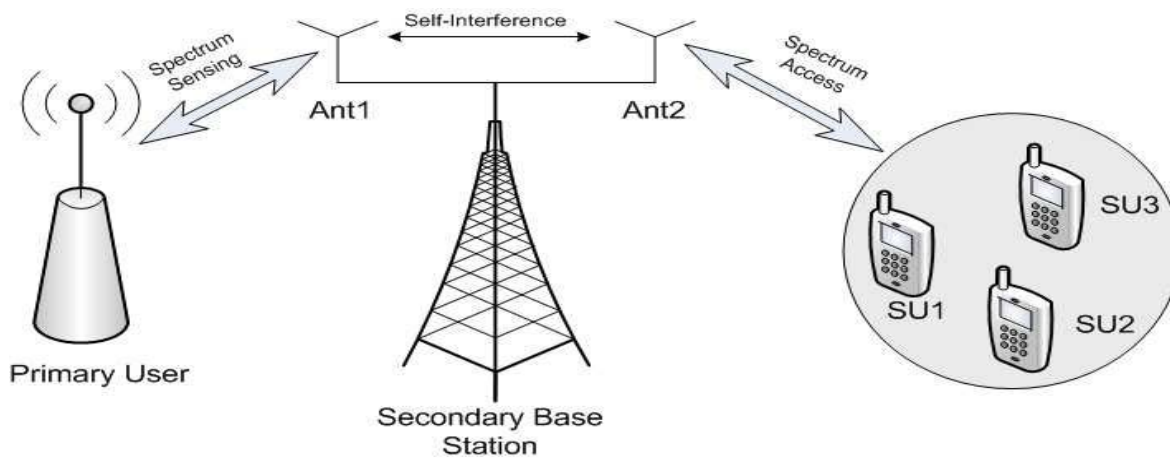

Fig. 3. Illustration of the FD-CRN cellular architecture [96], [97]: The secondary base station (SBS) is equipped with FD antennas to perform spectrum sensing and transmissions.

especially WiFi networks, has been extensively studied and we give here a brief overview of this FD-WiFi area. On the other hand, FD-WiFi networks with CR capabilities have only been considered in one study to date, which we review in this section.

The first studies of FD-WiFi networks with off-the-shelf radios have been carried out in [86] and [133]. Subsequently, the practical real-time implementation of FD-WiFi networks has been advanced in [80], [134], and [135]. Passive SIS [136]–[138] (see Section VI-B) has mainly been considered for minimizing the SI in FD-WiFi networks, while a hybrid SIS approach has been implemented in [139]. The delay minimization in FD-WiFi networks has been considered in [132]. Multiple antennas for FD communication in WiFi networks with advanced SIS have been discussed in [140]. Specifically designed MIMO antennas for FD-WiFi networks have been employed in [5].

To date, very little progress has been made for achieving the FD capability in CR enabled WiFi networks. To the best of our knowledge only the study [122] has considered the use of newly freed white space from the analog TV bands for FD-WiFi networks. In the considered low-power and low-frequency FD-WiFi networks, the SUs with FD radios mitigate the SI with a passive SIS approach (see Section VI-B). The use of omni-directional antennas in the examined FD approach increases data rates compared to HD systems.

2) *FD Cognitive Cellular Networks*: The support for FD cognitive radio networking has been examined in the context of conventional cellular network architectures as well as advanced cellular architectures, such as small cell, LTE, and 5G network architectures. Design paradigms for transceivers of FD-cognitive cellular and FD-cognitive ad hoc networks have been provided in [123]. An optimization approach is used to minimize the sum of all mean-squared errors (MSEs) which are subject to the power constraints. The power allocation is also optimized. The proposed FD approach for cognitive cellular networks improves the throughput with the help of digital SIS approaches (see Section VI-C1).

The transmission imperfections in FD cognitive cellular networks have been addressed in [124] through a cooperative HD and FD approach. This approach follows a basic architecture with a cognitive base station (CBS). To provide the cooperation, the CBS is connected with the primary base station (PBS) as well as PUs and SUs. Through the CBS, the SUs sense the licensed band and then transmit the data when the channel becomes idle. Four antennas for transmission and two antennas for reception are used to mitigate the SI and transmission imperfections.

Cloud-radio access network (C-RAN) structures have been exploited for FD-CRNs [125]. Specifically, an information theoretic approach has been employed to achieve FD gains in a cognitive cellular network with the C-RANs architecture. The inter-cell interference and the SI have been efficiently mitigated by employing an information theoretic approach and a digital SIS approach, respectively (see Section VI).

The co-existence of LTE based FD-CRNs with WLANs has been studied in [96]. The FD-LTE capable transceiver employs the cyclostationary spectrum sensing approach (see Section VII) to utilize the white space. A hybrid SIS approach (see Section VI-D) is used to efficiently mitigate the SI and the detection probability is compared with the corresponding HD-CRNs. Spectrum access with power allocation in FD-cognitive cellular networks has been studied in [97]. For this purpose, the secondary base station (SBS) is provided with FD capability with energy-based spectrum sensing and propagation-based SIS, as illustrated in Figure 3. The SBS is responsible for sensing the spectrum and then allocating the free channels to the SUs. In this architecture, the SI is only suppressed at the SBS. Then, a power-throughput tradeoff is exploited to achieve spectral efficiency.

The data rate can also be enhanced with the help of advanced cellular network architectures, such as small cells [141]–[143]. In particular, small cells with the FD communication system can be used for doubling the data rate [144], [145]. Advanced networks, such as 3GPP LTE small cells, can harness the benefits of the FD communication, as has been implemented in [146]. 5G networks with

FD capability have been presented in [144] for achieving high data rates. However, the FD capability in conjunction with CRs has not yet been examined in these advanced cellular network architectures.

3) *Other Miscellaneous Network Architectures Based on FD-CRNs*: This subsection briefly discusses FD communication in various other networks, such as wireless personal area networks (WPANs) and wireless powered networks. FD communication in WPANs with a single channel has been examined in [126]. Wireless powered networks with FD capability can enhance the network throughput, e.g., in wireless sensor networks [127]. FD-CRNs based on these other network architectures are a wide open future research area.

C. Summary and Insights

In this section, we have surveyed network architectures that support FD-CRN communication. We have classified the FD-CRN architectures according to the type of white space utilization and according to the type of underlying wireless network architecture. FD-CRNs with underlay white space utilization with OSA have been presented in [111]. The power allocation is a critical issue in FD-CRNs with underlay white space utilization and has been examined in [112]–[115]. The performance of FD-CRNs with underlay white space utilization has also been analyzed in [118] and [119]. FD-CRNs with overlay white space utilization with OSA have been discussed in [111]. The LAT protocol has been developed using simple FD radios in the existing interweave CRNs architecture in [100]. The first practical study of FD-CRNs has been presented in [99], while the first PIC for FD-CRNs has been implemented using the interweave white space utilization paradigm in [103].

FD-cognitive cellular networks can achieve higher data rates compared to simple HD-cognitive cellular networks. The study [123] provides design paradigms for FD-cognitive cellular network architectures. The transmit imperfections in FD-cognitive cellular network architectures have been addressed in [124]. C-RANs [125] and LTE [96] have also been integrated into FD-cognitive cellular networks with advanced SIS.

From the perspective of white space utilization, underlay and interweave FD-CRNs have been studied extensively. However, very limited work has been done on architectures that employ the overlay and hybrid white space utilization in FD-CRNs. Also, most of the studies involve the ON/OFF random process for monitoring the PU activity. There is a need to consider other PU activity models, as discussed in [40], for the different white space utilization types in FD-CRNs.

FD-cognitive WLANs have not yet been explored in detail, except in [122], which used the newly freed analogue TV band for communication. To the best of our knowledge, very limited work has been done on WPANs and small cells that can take into consideration both FD and CR capabilities. Energy harvesting architectures, which can overcome the energy scarcity, has been widely discussed for HD-CRNs. However, very limited work on energy harvesting architectures that could support FD-CRNs has been done to date.

V. RADIO REQUIREMENTS AND ANTENNA DESIGN FOR FD-CRNs

It is generally not possible for radios to receive and transmit on the same frequency band because of the interference that results.

A. Goldsmith, *Wireless Communications*, 2005 [85]

With the advances in SIS approaches, such as analog and digital SIS, the dream of FD communication can now be realized. Usually, the FD radios in CRNs should be capable of simultaneously sensing a wide range of spectral frequency and transmitting within the dynamic environment.

The FD antennas in CRNs should take into consideration various parameters to achieve the theoretical doubling of the throughput. The FD-radios should be capable of (i) mitigating the SI that results from local transmitters overwhelming the received signals, (ii) handling the link-layer delays, and (iii) supporting approaches for minimizing wireless link errors and path-loss. For these purposes, a wide variety of antenna techniques have been proposed, as summarized in Figure 4.

A. Antenna Techniques for FD-CRNs

Various antenna configuration techniques have been used to enhance the ergodic capacity of FD-CRNs. More specifically, various antenna configuration techniques have been used for reducing the spatial correlation and increasing the ergodic capacity between the transmit and receive antennas.

1) *Directional Antenna*: Directional antennas are used in FD-CRNs when the gain of the transmit antennas in the direction of the receiver is low. The use of directional antennas in FD-CRNs can increase the gain and transmission range. Directional antennas are also used to passively suppress the SI (see Section VI-B).

Directional antennas in FD communication with passive SI suppression have been examined in [137] in the context of an FD-based WiFi network (without CRs). The use of directional antennas results in the achievable sum rate with the wireless open-access research platform (WARP). The infrastructure nodes achieve improved throughput with the directional antennas. Directional antennas have also been utilized in the FD-WiFi based distributed network topology [138]. This study shows that the use of directional antennas for FD communication (without CRs) is a cost-effective and reliable solution to increase the throughput. This approach also supports the propagation and digital SIS to effectively counter the SI.

To increase the gain and range, and to mitigate the SI, directional multi-configurable antennas (MRAs) have been proposed for FD-CRNs in [99]. The FD-MRAs increase the rate gain and transmission range in the direction of the receiving antenna. The range rate has been characterized for this MRA and the increase has been compared with omnidirectional antennas in HD and FD systems. The same transmit power has been used for both the directional and omnidirectional antennas. The hybrid SIS approach (see Section VI) has been implemented with these directional FD-MRA antennas to efficiently suppress the SI at the RF, analog, and digital

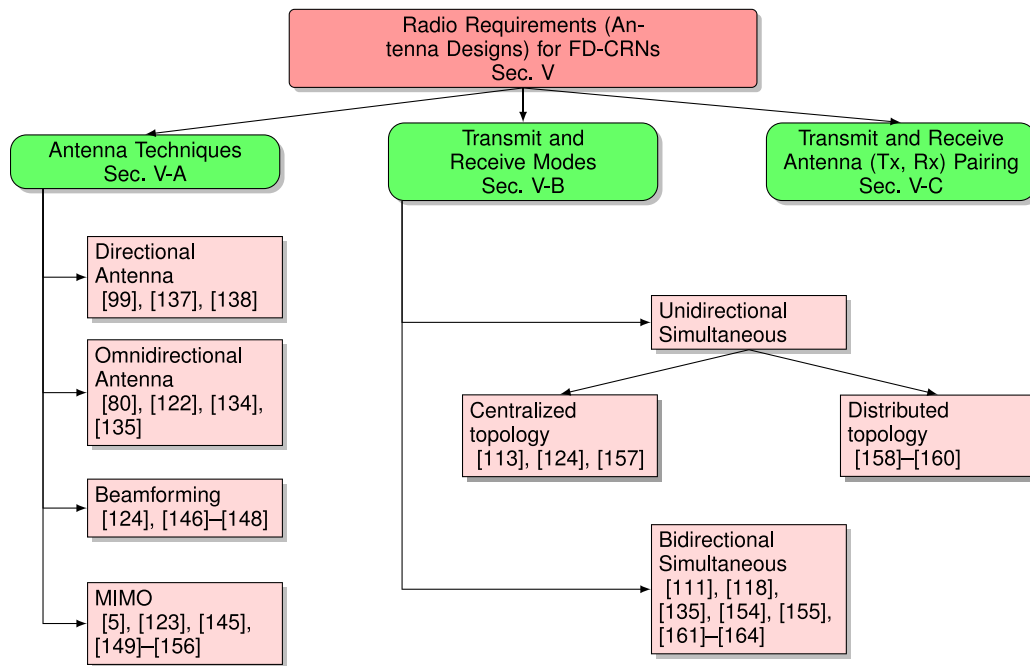

Fig. 4. Radio requirements for FD-CRNs are based on the antenna techniques, transmit and reception modes of antennas, and antenna pairings employed for the FD operation in CRNs.

circuits. The evaluation study in [99] indicates that these antennas improve the throughput and formulates design paradigms for the potential use of FD communications in CRNs.

2) *Omnidirectional Antenna*: In contrast to a directional antenna, an omni-directional antenna propagates the signals in all directions. The study [122] has examined the use of a nulling antenna, which has a propagation pattern closely related to the omni-directional antenna, in FD communication. The FD communication with the nulling antenna uses the low-frequency band that is freed by the TV white space. With the examined Lyrtech software defined radio (SDR) platform [122], FD-WiFi networks utilizing the newly freed TV white spaces achieve improved throughput compared to the corresponding HD networks.

The practical implementation of FD networks with omni-directional antennas has been demonstrated for FD-WiFi networks without CR in [80]. This practical work could be extended to CRs. Signal inversion and adaptive cancellation are used to increase the capacity with a hybrid SIS approach. The omni-directional antennas in this approach have been used in conjunction with an FD-MAC protocol that reduces packet losses by minimizing the hidden terminal problem. In particular, access points (AP) with FD antennas help in suppressing the hidden terminals [80].

Another real implementation of FD systems with omni-directional antennas has been reported in [134]. In particular, the sub-carrier FD-enabled OFDMA physical layer has been used with an experimental WARP platform. The FD-physical layer with an omni-directional antenna increases the throughput and minimizes the delay with respect to an HD physical layer. Omni-directional antennas with off-the-shelf radios have been employed for FD communication in [135]. The FD operation with simple omni-directional antennas with off-the-shelf

components is supported by a proposed specific hardware module [135]. In this approach, the omni-directional antenna based FD communication (directional antennas can be used if needed) improves the throughput and minimizes the overall complexity.

3) *Beamforming*: The range of FD-systems in CRNs can be increased with the help of beamforming. Beamforming can be used both at the receiving and the transmitting antennas and mitigate the SI. SIS with beamforming has been extensively used in wireless systems [13]. A beamforming approach based on zero-forcing beamforming (ZFBF) has been studied in [147]. More specifically, the ZFBF based approach has been employed in full-duplex relay (FDR) systems based on cellular architectures. FDR systems show improved performance compared to half-duplex relay system when the isolation between the antennas is sufficient.

The FD capability with beamforming has also been studied in the context of small cell wireless systems [146]. A design paradigm with FD capable base stations (BSs) has been proposed in [146]. The design problem is formulated as a rank-constrained optimization problem, which is then solved with a rank relaxation method. The analytical results show that beamforming in a centralized topology mitigates the SI and improves the throughput. The spatial degree of freedom available to the FD-BS with the beamforming approach has been examined in [148]. FD-BS communication with propagation-based SIS (a form of passive SIS, see Section VI-B) utilizing beamforming shows better performance with spatial isolation compared to HD systems.

A hybrid scheme to select the optimal duplexing, either HD or FD, to achieve the desired gain with antenna beamforming has been proposed in [124]. This hybrid duplexing scheme with beamforming has been used in cooperative FD-CRNs

with cognitive base stations (CBSs). The rate region has been characterized in this beamforming scheme with a passive SIS approach. Simulation results indicate substantial performance gains with this hybrid mode as compared to utilizing only the HD mode.

4) *MIMO*: In FD-MIMO systems, the ergodic capacity is directly proportional to the number of used antennas, i.e., the ergodic capacity increases linearly as the number of antennas increases. FD-MIMO systems do not directly support the sharing of antennas. Cognitive radio (without MIMO) in ad hoc networks has been discussed in [165]. FD-cognitive ad hoc networks and FD-cognitive cellular networks with MIMO antennas have been studied in [123]. The MIMO antennas in these networks use a digital SIS approach to mitigate the SI and residual interference. The use of MIMO antennas in these FD-CRNs reduces the MSEs of all the estimated symbols that are subject to power constraints and increases the throughput compared to HD ad hoc and cellular networks.

Robust antenna designs for cognitive cellular networks with MIMO antennas have been studied in [166]–[168]. These studies consider imperfect channel state information (CSI). The studies address the minimization of the sum of the MSEs with respect to the imperfect CSI. In [166] and [167], the MSEs of all estimated symbols of imperfect channel states are formulated as a semi-definite program (SDP) which is then solved with an iterative algorithm.

The first FD-MIMO systems have been designed on the WARP platform in the context of multihop wireless networks [151]. 3 dB dipole antennas with propagation- and analog-based SIS approaches have been used in these FD-MIMO systems. The practical implementation of FD-MIMO has been examined in WiFi networks in [5]. In particular, implementing MIMO technology with off-the-shelf radios resulted in good throughput performance. The hybrid SIS approach has been used to mitigate the SI and to increase the robustness. For this practical implementation of the FD-MIMO antennas, the performance is compared to replications of SISO antenna designs. The proposed design shows better performance while countering the effects of the noisy indoor environment.

A pair of modems with FD MIMO antennas has been examined in [149]. The limited dynamic range and the SI have been taken into consideration and bidirectional communication has been achieved with the MIMO antennas through beamforming based on pilot-aided channel estimates. The studies in [149] and [152] address the issue of the limited dynamic range in FD-MIMO relaying. A transmission scheme has been developed to maximize the lower bound of the DF throughput of full-duplex MIMO relay systems. The digital SIS approach has been used to mitigate the SI and the performance of the system has been analytically evaluated.

A broadband FD-MIMO system has been developed and evaluated in [153]. The time-domain transmit beamforming (TDTB) in this broadband FD-MIMO system has been practically implemented and the performance of the system has been analytically evaluated compared to frequency-domain transmit beamforming (FDTB). Without penalizing the forward-channel, the SI in FD systems can

also been suppressed with FD-MIMO systems [154]. The self-interference pricing (SIP) approach has been used that takes into consideration the passive SIS with FD-MIMO systems. Extensive simulations with the bidirectional mode of transmission and reception have been performed. The simulations indicate the effectiveness of FD-MIMO systems compared to HD systems.

Energy-efficiency (ES) and spectral-efficiency (SE) have been investigated for FD-MIMO systems in [155]. In particular, a precoding has been proposed for this multiuser-MIMO (MU-MIMO) system to increase the ES and SE while minimizing the SI. The proposed MU-MIMO scheme has low complexity compared to HD-MIMO systems, since the non-convex pre-coding problem is approximated as a convex problem at each iteration. The work in [145] also considers the FD system MU-MIMO (FD MU-MIMO) communication approach. Various transmission approaches for the FD MU-MIMO system have been proposed and the performance of the system with respect to the throughput maximization has been evaluated. This approach can be implemented in small cell networks where energy is scarce. Decode-and-forward MIMO relays with FD capability have been proposed in [150]. The adaptive gradient-based SIS method (see Section VI) has been used to mitigate the SI in the FD-capable MIMO relays. The adaptive SI cancellation in the FD MIMO relays has been analytically evaluated for the DF operation. The proposed scheme attenuates the SI by 30 dB for a 6 dB SNR value, thus demonstrating the efficiency of FD-MIMO relays.

B. Transmit and Receive Modes for FD-CRNs

1) *Simultaneous Transmission and Reception*: Simultaneous transmission and reception on the same channel was not possible in traditional wireless communication due to the high SI at the receiving antenna. However, advances in SI suppression enabled the FD technique with simultaneous transmission and reception. This simultaneous transmission and reception results in the theoretical doubling of the throughput compared to HD communication. FD communication systems with simultaneous transmission and reception of signals for various general wireless networks (without CR) have been proposed. For example, FD systems with simultaneous transmission and reception of signals in WiFi networks have been studied in [5], [80], [86], [122], [133], and [137]. Most of these studies use the passive SIS approach (see Section VI) to mitigate the SI. Other wireless networks, such as FD-cellular networks [147], FD MU-MIMO [145], FD 3 GPP LTE small cells [146], FD 5G networks [144], wireless powered FD network [169], also employ the FD mode of communication with simultaneous transmission and reception.

In FD-CRNs, the simultaneous sensing, transmission, and reception of data also results in increased SI. However, with the advances in passive and active SIS approaches, FD-CRNs can support the simultaneous sensing, transmission, and reception. We consider initially unidirectional simultaneous transmission and reception, whereby only the SUs are capable of FD operation; bidirectional simultaneous transmission and reception, where SUs and PUs are capable of FD

communication, is covered in Section V-B2. The majority of the existing studies examines the unidirectional simultaneous transmission and reception scenarios in either centralized mode or distributed mode, as illustrated in Fig. 4.

a) Centralized mode: The centralized mode of transmission and reception has been examined in [113], [124], and [157]. Amplify-and-forward (AF) FD-CRNs with simultaneous sensing, transmission, and reception radios have been studied in [157]. For this AF approach, the optimal power-allocation with respect to the cognitive relays has been examined in the context of multihop networks. The instantaneous channel information is obtained and the limited cooperation between the cognitive transmitter and the cognitive relay is used to achieve the FD mode with an efficient SIS approach. Transmission imperfections during the FD operation can also be minimized in FD cooperative CRNs [124]. In particular, for cooperative CRNs, a hybrid HD and FD scheme with characterization of the rate region has been proposed in [124]. The imperfections related to the transmissions are addressed by maximizing the cooperation between the PUs and SUs with the help of a CBS. For this purpose, the cognitive rate maximization problem is solved by taking into consideration the primary-cognitive rate region.

The simultaneous sensing, transmission, reception are further strengthened with the help of beamforming. Underlay FD-CRNs with simultaneous sensing, transmission, and reception of packets at SU FD antennas have been studied in [113]. The propagation-based SIS approach has been used to achieve doubled throughput compared to the HD mode. The power-throughput tradeoff has been characterized to gain the optimal performance. To efficiency control the power-throughput tradeoff and ensure stability, a proportional-integral-derivative (PID) controller has been used in [113] in conjunction with a power constraint mechanism.

b) Decentralized mode: The decentralized mode for transmission and reception has been examined in [158]–[160]. The simultaneous sensing, transmission, and reception in FD-CRNs with hybrid SIS has been studied in [158] for a decentralized network topology. Energy-based sensing (see Section VII-B) simultaneously with transmission and reception minimizes the PLR and increases the throughput compared to the HD operation in the decentralized network topology. Another cooperative approach in FD-CRNs has been examined in [160] for distributed relaying. More specifically, the SU transmitters simultaneously send and receive packets, and help the PUs by delivering their unsuccessful packets.

Collisions in FD-CRNs can deteriorate the overall sensing and transmission performance. The reduction of the collision probability in FD-CRNs with simultaneous sensing and reception has been studied in [159] for the distributed FD-CRN topology. An ON/OFF spectrum sensing model is employed to minimize the collision probability in the simultaneous operation mode.

2) Bidirectional Simultaneous Transmission and Reception: Bidirectional simultaneous transmission and reception scenarios in FD communication have also been used to gain the doubled throughput compared to the HD mode. In unidirectional simultaneous transmission and reception, only the SUs

are capable of FD operation, while in *bidirectional* simultaneous transmission and reception, the other devices, such as the PUs or other lower-end SUs, are also capable of FD communication. The term bidirectional simultaneous transmission and reception has been used in a few studies. such as [111]. The bidirectional mode of transmission and reception using FD radios has been extensively used in general wireless communication (without CR). In particular, the FD bidirectional capability has been examined for FD-WiFi networks [135], FD-MIMO [154], FD MU-MIMO [155], and energy harvesting FD wireless networks [163]. The various design paradigms for bidirectional scenarios have been discussed in [162].

Underlay and overlay FD-CRNs with OSA can use the unidirectional and bidirectional modes of simultaneous transmission and reception as studied in [111]. The SIS approach with ON/OFF model of spectrum sensing has been used. A hybrid duplexing approach using both half-duplex and full-duplex mode has been proposed. This hybrid approach employs a switching algorithm to switch between the HD and FD mode. The proposed scheme increases of throughput as compared to the HD scheme.

C. Transmit and Receive Antenna (T_x , R_x) Pairs for FD-CRNs

Different pairings of antennas are used to simultaneously sense and transmit in FD-CRNs. An important question is which antenna should be used for transmission and which antenna for the sensing in FD-CRNs. This question has been resolved in [170]. This selection depends on the channel information. However, different network topologies use different numbers of transmit and receive (T_x , R_x) antenna pairs and employ different SIS approaches to mitigate the SI to achieve the desired throughput and spectral-efficiency. The thorough study of efficient FD communication for these different topologies, antenna pairings, and SIS approaches is an important area for future research.

D. Summary and Insights

In this section, we have provided a detailed description of the antenna techniques, approaches, and design paradigms for FD-CRNs. Different antenna techniques, such as directional antenna, omni-directional antenna, beamforming, and MIMO, have been used to achieve the FD capability in CRNs. The literature review reveals that only relatively little work has been done to date on the various antenna types in FD-CRNs. Most of the work on FD-CRNs has considered directional and MIMO antennas; the thorough examination of the other antenna approaches is an important direction for future research.

The directional MRA antenna in FD-CRNs [99] minimizes the SI and increases the throughput. The TV white space has been exploited with omni-directional antennas in [122]. Beamforming can increase the range and suppress the SI in FD-CRNs [124]. The implementation of FD-cognitive ad hoc networks and FD-cognitive cellular networks has been presented in [123]. The impact of the simultaneous transmission and reception on the packet loss ratio has been examined

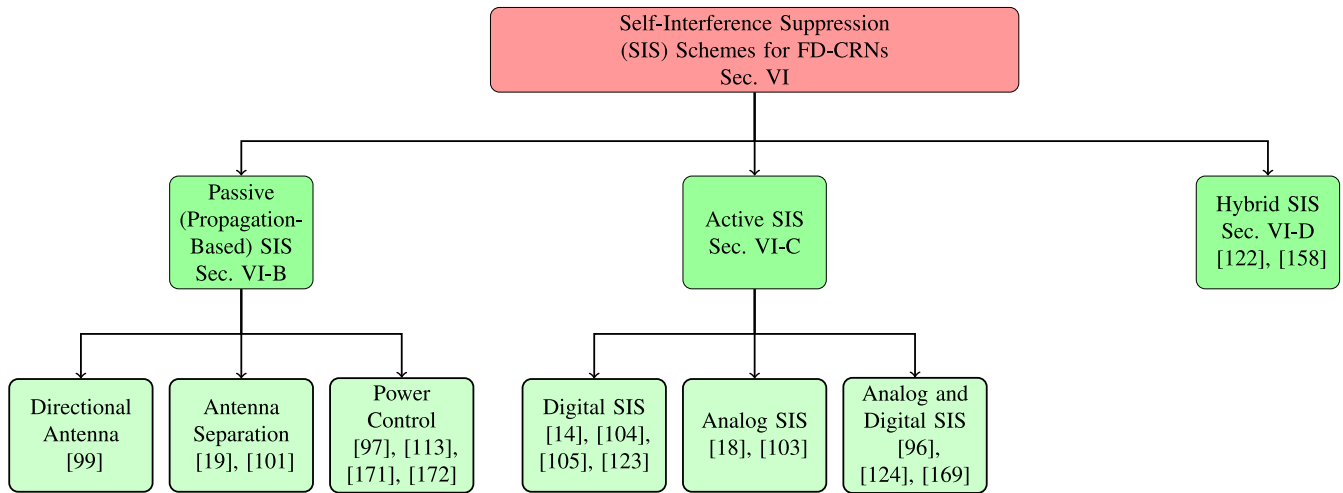

Fig. 5. Self-interface suppression (SIS) approaches for FD-CRNs can be categorized into passive, active, and hybrid SIS approaches. The active SIS approaches can further be classified into digital, analog, as well as hybrid digital and analog SIS approaches.

in [158] and [159], while cooperative FD-CRN communication has been examined in [124] and [160]. The power-throughput tradeoff for the simultaneous sensing, transmission, and reception of the signals has been characterized in [113] and [157].

Designing the FD antennas to efficiently suppress the SI from the transmitting antenna is a key factor to achieve FD communication in CRNs. The existing work on FD-CRNs takes into consideration the antenna placement, antenna separation, and antenna cancellation for efficiently suppressing the SI. However, only very limited work has considered achieving quality of service (QoS) by minimizing the signal-to-interference-plus-noise (SINR) ratio at the receiving antenna. Moreover, MIMO can be viewed as combinations of N single SISO antennas. With increasing numbers of antennas, the complexity also increases. The existing studies on FD-MIMO for CRNs have not yet addressed these complexities in detail.

VI. SELF-INTERFERENCE SUPPRESSION (SIS) IN FD-CRNs

A. Need for Advanced SIS Approaches in FD-CRNs

The simultaneous operations of transmission, reception, and sensing of PU activity in FD-CRNs face severe SI at the receiving SU antennas. Therefore, the potential benefits of FD communication can only be reaped with the advancement of effective SIS approaches [173]. FD communication can theoretically double the throughput and spectral efficiency. However, FD communication can outperform the HD, only if the SI at the local transmitter is effectively mitigated. An SI level of 3 dB below the noise level at the local input of the FD does not degrade the system performance and results in improved throughput compared to HD systems [174].

With SIS approaches, the spectral and throughput efficiency of FD-CRNs can be enhanced compared to HD-CRNs [175]. However, even after the suppression of the SI, the residual interference could still degrade the system performance. Therefore, a hybrid FD/HD approach is used in some scenarios to gain the desired throughput and spectral-efficiency [124].

In summary, the SIS in FD-CRNs faces various challenges, including:

- The antennas in FD communication must be optimally separated from each other. The distance between the transmitting and receiving antennas should be controlled such that the residual interference does not degrade the system performance.
- The SIS approaches should not interfere with the approaches that are used to counter the interference between the SUs while sensing and utilizing the licensed channels of the PUs.
- The transmit power must be optimally controlled to avoid the SI. Increased power can enhance the connectivity and coverage. However, increased power can also cause more interference. Hence, FD-CRNs require optimized transmit power settings so as to achieve spectral efficiency gains with the use of SIS approaches.
- The type of SIS approach that should be employed is a critical design choice for FD-CRNs. Passive SIS, active SIS, or combinations thereof can be used to address the interference created by the FD-CRNs.

Figure 5 shows the classification for the SIS approaches used in FD-CRNs. We have classified the SIS approaches based on the treatment of the input signal. The signal can be treated passively, actively, or in a hybrid way. Accordingly, active SIS, passive SIS, or a hybrid combination thereof is commonly used to mitigate the SI. We have adopted this classification of SIS approaches into active, passive, and hybrid SIS approaches for our survey. Alternatively, the SIS approaches can be classified into power dependent and independent SIS approaches [176], optical SIS approaches [177], or into perfect and imperfect SIS approaches [111], [159].

B. Passive SIS Approaches in FD-CRNs: Propagation-Based SIS

Passive SIS is carried out before the signal actually enters the receiving antenna [72]. Passive SIS suppresses the SI by

exploiting various antenna and signal propagation characteristics, such as antenna separation, antenna shielding, and antenna polarization effects. In particular, passive SIS takes into consideration various propagation characteristics related to the antennas. The propagation-based SIS mitigates the SI at the entrance to the RF amplifier.

We first briefly review passive SIS for general FD communication (i.e., not specifically for CR communication) to cover the basic operation and trends of SIS approaches in general FD communication. Various passive SIS approaches have been adopted in general FD wireless networks. For example, antenna cancellation has been exploited in FD wireless networks [178]. A two level antenna cancellation has been developed in [178] to suppress the SI with the use of a signal nulling approach. Zero-forcing beamforming (ZFBF) can be used to suppress the SI while supporting the multiuser MIMO operation [147]. In this case, ZFBF is used not only to suppress the SI but also the multiuser interference [147].

Another approach to mitigate the SI in FD-MIMO systems considers the forward channel. For this purpose, a self-interference pricing (SIP) approach has been used to achieve a balance between the SIS and the forward channel maximization [154]. What should be the exact number of antennas for optimal FD operation? This has been answered in [162]. The transmit-receive antenna pair selection (TRAPS) scheme for bidirectional FD communication has been proposed while taking into consideration the SIS at the receive and transmit antenna pair.

The SUs in FD-CRNs can simultaneously sense and transmit while using various numbers of FD antennas, which may follow different design paradigms. However, without an SIS approach, the SI resulting from the simultaneous transmission and reception of signals would render the decoding process inefficient, increase the probability of false alarms, degrade the system performance, and waste the majority of the spectrum holes. These issues can be addressed very well with passive SIS approaches. We proceed to survey the passive SIS approaches in FD-CRNs that take into consideration various antenna designs, distance, placement, and power control strategies to suppress the SI.

1) *Directional Antennas for Passive SIS in FD-CRNs:* The usage of directional antennas for SIS in FD-CRNs can enhance the rate gain and transmission range compared to omnidirectional antennas. A passive SIS scheme for CRNs based on directional antennas has been proposed in [99]. The SUs are equipped with FD capable directional antennas that can simultaneously sense and transmit. The study [99] analyzes the resulting rate region achieved with FD communications to assess the potential of FD communication for CRNs. The evaluation found that the use of directional antennas increases the transmission range of FD-CRNs compared to omni-directional antennas.

2) *Antenna Placement (Separation) for Passive SIS in FD-CRNs:* An FD-CRN design paradigm for achieving high spectrum efficiency and throughput with two antennas, one for sensing and the other one for transmission, to exploit the FD capability in CRNs has been studied in [19]. The self-interference is suppressed by optimally adjusting the distance

between the two antennas. The proposed FD-CRN design with the optimally spaced antennas is examined for centralized and distributed scenarios. SUs with two antennas with physical isolation have also been studied in [101]. In particular, the SI reduction achieved through the physical isolation between the two FD antennas has been studied in [101]. In the examined set-up, the SUs use a so-called upper antenna for the transmissions and a so-called lower antenna for sensing the PU activity.

3) *Controlling Power for Passive SIS in FD-CRNs:* Traditionally, CRNs employ the listen-before-talk (LBT) protocol, whereas FD-CRNs employ the listen-and-talk (LAT) protocol. The relationships between power and SI for the LAT protocol have been studied in [100] when energy detection is used for spectrum sensing under imperfect SIS. When the transmit power is low, the SI is almost negligible. On the other hand, when increasing the antenna transmit power, the SI can overwhelm the entire communication process and throughput decreases. Therefore, a power-throughput tradeoff exists for the LAT protocol in FD-CRNs. Based on this trade-off, the optimal transmission power should be selected to achieve the desired throughput.

FD can also be used in cellular systems [179]. The SIS at the base station (BS) and user equipment nodes (UEs) makes it possible to double the capacity of cellular networks. Usually, the FD-BS [148], has been developed for simple FD-cellular networks. In contrast, in FD cognitive cellular networks, a secondary base station (SBS) is used. The SBS is equipped with FD antennas to gain the desired spectral-efficiency and performance [97]. The SBS is equipped with two antennas for the sensing and transmission operations, respectively, as illustrated in Figure 6. When the SU or SBS are equipped with two antennas, an increase in the power of the transmit antenna results in SI at the sensing antenna. The optimal power allocation to the transmit antenna in SBS is used as the main SIS mechanism. Power is also used as the SIS control factor in FD underlay CRNs [113], [171], [172]. In these underlay CRNs, a distributed power control scheme employs proportional integral derivative (PID) control for SIS. The PID control based hybrid HD/FD approach outperforms HD communication while actively suppressing the SI at the cognitive relay nodes [113].

C. Active SIS in FD-CRNs

The active SI approach actually works when the signal enters the receiving antenna. The potential of FD communication can only be achieved when effectively suppressing the SI and reducing the bit error rate (BER) [72]. In active SIS, the SI is reduced by 40–50 dB through a combination of a radio frequency (RF) canceller and a baseband canceller [175]. The active SIS approaches can be further sub-classified into digital SIS approaches, analog SIS approaches, and hybrid digital-analog approaches, as illustrated in Fig. 5.

1) *Digital SIS Approaches in FD-CRNs:* Digital SIS can cancel the SI that results from the phase noise of the oscillator and nonlinearities in the receiver analog-to-digital converter (ADC). For digital SIS, the dynamic range of the

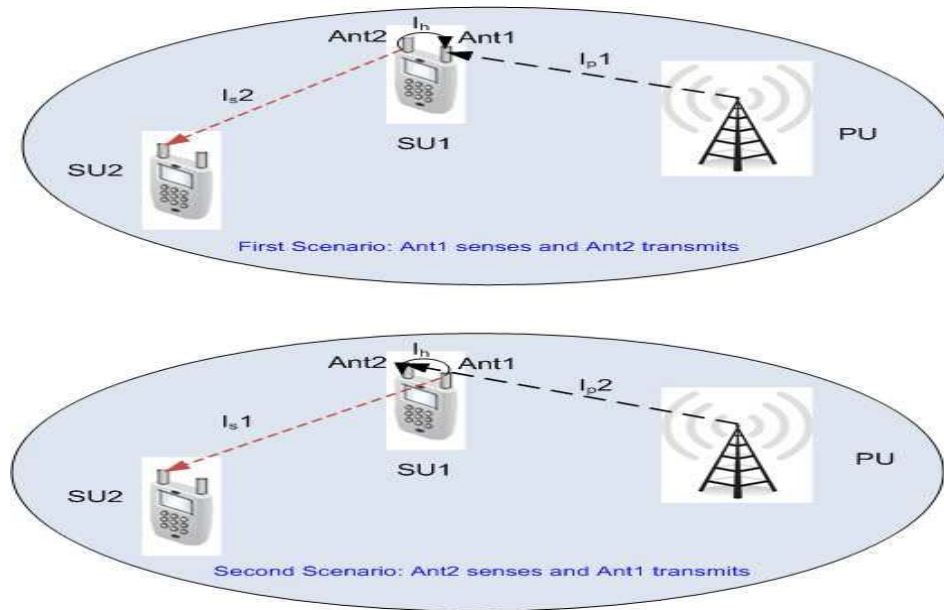

Fig. 6. Illustration of SUs with two antennas (Ant1 and Ant2) provided with FD capability. In the first scenario, Ant1 at SU1 senses the signal I_{p1} from the PU, while Ant2 transmits the signal I_{s2} ; the resulting self-interference is I_h . In the second scenario, Ant1 transmits I_{s1} and Ant2 senses I_{p2} . For both scenarios, the impacts of SI and SIS approaches need to be examined.

receiver ADC is a major problem. In FD communications the SI can be canceled at an effective dynamic ADC range of approximately 6.02 (ENOB-2) dB [87]. Other types of SI are the linear and non-linear SI that can also be controlled with the help of digital SIS [72].

Digital SIS in FD-CRNs has been achieved through various approaches. The SI has been modeled as Gaussian noise in FD-CRNs [104]. With the presence of two antennas at SUs in cooperative CRNs, this method of modeling the SI is helpful for spectrum sensing. Spectrum sensing in conjunction with a digital SIS approach in an FD-enabled cognitive MAC protocol has been proposed in [14] (for details about MAC protocols, see Section VIII). The collision probability has been reduced by extending the sensing period, whilst utilizing digital SIS to suppress the SI. Another distributed FD-MAC protocol with digital SIS during the spectrum sensing has been proposed in [105]. The optimal power allocation has been studied under this MAC protocol to characterize the trade-off between the throughput and power. To digitally suppress the SI, a configuration algorithm has been proposed that sufficiently suppresses the SI by introducing the trade-off between the throughput and the SI.

We conclude this general overview of active digital SIS by giving a brief overview of emerging approaches for general networks, which could be adapted to CRNs in the future. A mean-squared error (MSE) based transceiver can be designed while taking into consideration the limited dynamic range of the receiver [123]. Digital SIS can then minimize the sum of the MSEs. This approach can also be used in FD-cellular systems. The SI in cloud radio access networks (CRANs) can be suppressed using a digital SIS approach [125]. In particular, an information theoretic approach that is based on classical Wyner model can be used for the SIS [125].

2) *Analog SIS Approaches in FD-CRNs*: Analog SIS is used to tackle the SIS at the analog-to-digital converter (ADC). Sequence-based methods or adaptive interference cancellation are commonly used for analog cancellation [72]. Combinations of time-domain algorithms, such as training-based methods [180], are used by the analog SIS approaches for both SISO and MIMO systems [175]. A photonic integrated circuit (PIC) has been designed for FD-CRNs in [103]. The analog SIS using the photonic filter enables the cognitive users to efficiently harness the wide band. The PIC accepts two signals, the received signal and the known transmitted signal. The two signals are passed through the photonic filter, which subtracts the transmitted signal from the received signal to suppress the SI. The transmitted signal is also used by the feed-forward approach [18] to suppress the SI using an analog SIS. In this approach, the cancellation vector, which is the combination of the transmitted and other signals entering the receiver, is used to cancel the SI.

3) *Hybrid Analog and Digital Active SIS Approaches in FD-CRNs*: A single analog or digital active SIS approach is often not enough to sufficiently mitigate the SI. Therefore, a combination of analog and digital SIS approaches is often required to effectively mitigate the SI [136]. Generally, in FD wireless communication, especially in cellular networks, combinations of both analog and digital approaches are commonly used to overcome the SI [169].

Similarly, FD-CRNs usually employ both analog and digital active SIS to achieve the desired throughput. For instance, the SUs in cooperative FD-CRNs suppress the SI using both analog and digital approaches in [124]. In particular, a full-duplex cognitive base station (FD-CBS), which is similar to the concept of a secondary base station (SBS), implements the amplify and forward (AF) or decode and forward (DF)

relaying approach, and then suppresses the SI using an active SIS approach. Analog linear cancellation (ALC) and digital linear cancellation (DLC) are also used in designing FD-CRNs [96]. Thereby, the impact of SI in cyclostationary spectrum sensing in LTE-unicast (LTE-U) is minimized with the help of both ALC and DLC.

D. Hybrid Passive and Active SIS Approaches in FD-CRNs

Hybrid SIS approaches that combine active and passive SIS have been extensively used to suppress the SI and to harness the potential of FD communication. To date, most research on hybrid SIS has focused on FD WiFi networks. WiFi-based FD wireless communication with hybrid SIS approaches has been examined in [133]. The various hybrid SIS approaches have been implemented using the experimental WARP platform. WiFi networks with WARP platforms and hybrid SIS approaches that achieve the theoretical doubling of the throughput with FD communication have also been studied in [5], [80], [86], [134], and [137]. The use of directional antennas in FD WiFi networks with a decentralized topology has also been examined in the context of hybrid SIS approaches [138]. The use of omnidirectional antennas in FD-WiFi networks in conjunction with hybrid SIS approaches has been studied in [135]. The impact and comparative analysis of the probability distributions of the SI on the channel with various SIS approaches have been characterized for FD-WiFi networks [139]. The practical implementation of FD-WiFi networks with hybrid SIS is presented in [149]. This practical implementation considers the centralized topology, and throughput is compared to HD networks. Modem-based FD communication with multiple transmit and receive antenna pairs has been analyzed with respect to the hybrid SIS approaches in [136].

SUs in FD-CRNs can harness the FD-capability only when the SI is below the noise threshold. To suppress the SI, FD-CRNs have been designed to employ both active (analog and digital based) SIS and passive (propagation-based) SIS approaches to effectively suppress the SI. In hybrid SIS approaches, the propagation-based SIS is usually employed first, and is then followed by the active (analog and digital) SIS approaches. In [158], the antenna cancellation (propagation-based SIS) is used first to remove the SI. The remaining SI is then suppressed by using the RF interference cancellation (analog SIS) and digital SIS. Both active and passive SIS approaches are implemented using the single antenna and the proposed FD-CRNs reduce the packet loss ratios compared to HD-CRNs. The white spaces that result from the previously used analog TV bands can also be used for FD communication [122]. The indoor WiFi network in [122] uses the low frequency band that is based on the TV white space. The SI has been suppressed with passive and analog approaches while using an omnidirectional antenna.

E. Summary and Insights

In this section, we have provided an extensive survey of the various SIS approaches for FD-CRNs. The SI in FD communication can overwhelm the received signal and degrade the

throughput of FD-CRNs. The performance of an FD system can drop below that of the corresponding HD system if the SI is not properly suppressed. The SI is typically suppressed via active or passive approaches. However, the proposed SIS approaches do not take the various PU activity patterns of FD-CRNs into consideration. The SI in the presence of the various levels of PU activity has not yet been modeled to validate the effectiveness of the various SIS approaches.

The use of both digital and analog active SIS approaches can sometimes increase the SI. To address this issue and to effectively suppress the SI, pre-defined suppression values should be used [139]. However, the existing studies on SIS approaches in FD-CRNs have not taken the measured suppression values into account.

The signals are usually first treated with the passive SIS approach. For instance, directional antennas are part of the passive SIS approach in [99]. Design guidelines for achieving FD communication in CRNs with passive SIS approaches have been provided in [19]. Throughput-power tradeoffs in relation to passive SIS have been examined in [100] and [113]. In [101], the physical isolation between the transmitting and sensing antennas of the SUs has been studied.

Active SIS in FD-CRNs can be categorized into digital and analog SIS. The cooperative FD-CRNs in [104] use the digital SIS approach and modeled the SIS as Gaussian noise. The digital SIS in FD-CRNs can reduce the collision probability as examined in [14]. The throughput-power tradeoffs with respect to the digital SI have been studied in [105]. The study [103] designed a PIC to support the FD operation in CRNs and minimized the SI with an analog SIS approach. A feedback forward approach has also been used in FD-CRNs [18] and the SI has been suppressed using an analog SIS approach. To perfectly mitigate the SI, combinations of active and passive SIS have been proposed in [122] and [158]. In hybrid SIS approaches, the passive SIS is applied first, followed by the active analog and active digital SIS approaches.

A critical future SIS research area for FD-CRNs is in the context of 5G wireless networks. The increased number of users and higher data rates envisioned for 5G systems can result in spectrum scarcity. Spectrum scarcity can be mitigated by introducing the CRN capability in 5G networks. The FD-CRN capability for 5G networks can further enhance the throughput compared to HD-CRN 5G networks [169], [175]. However, the main hurdle in achieving the full potential of FD-CRNs in 5G networks is the SI. There is an urgent need to further improve the SIS approaches to achieve increased throughput compared to HD-CRNs in the context of 5G networks.

VII. SPECTRUM SENSING IN FULL-DUPLEX COGNITIVE RADIO NETWORKS (FD-CRNs)

The CRN spectrum management consists of spectrum sensing, spectrum decisions, spectrum sharing, and spectrum mobility [188]. Among these tasks, the spectrum sensing is highly important to initiate the CR operation with the availability of various spectral resources. Obtaining the information about the available spectrum bands, monitoring the

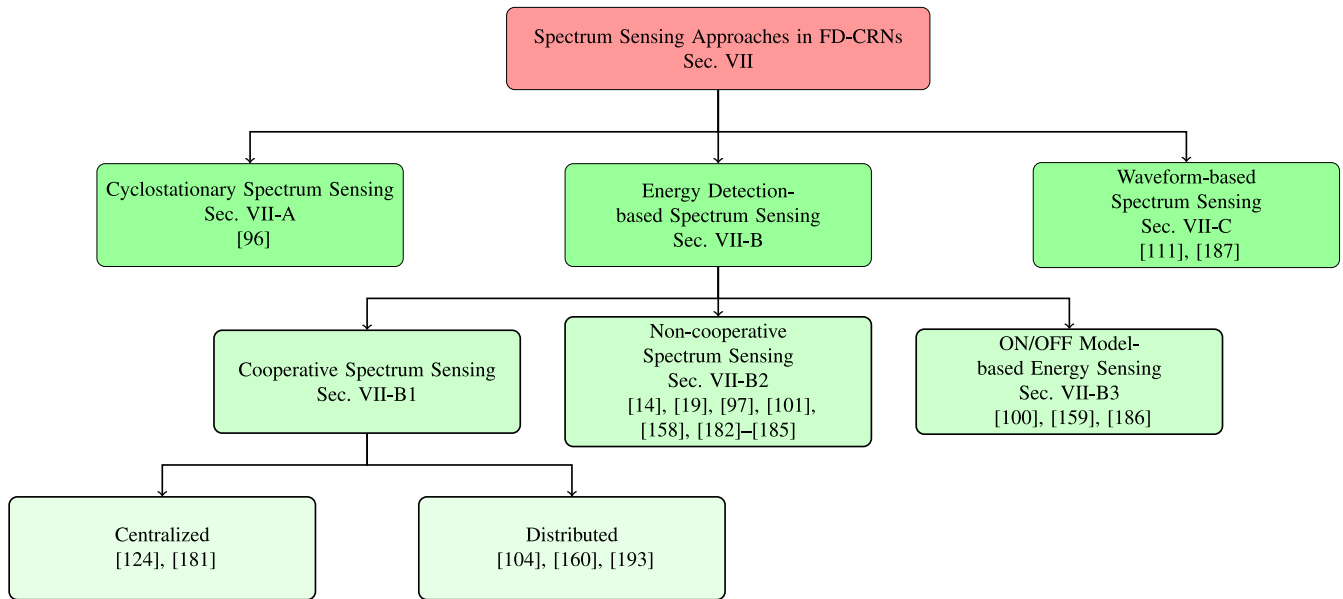

Fig. 7. The spectrum sensing approaches employed in FD-CRNs can be broadly classified into cyclostationary-based, energy-detection-based, and waveform-based spectrum sensing approaches. The energy-detection-based spectrum sensing can further be classified into cooperative (centralized or distributed), non-cooperative, and ON/OFF model-based spectrum sensing.

PU activity, and then detecting the available white space for transmission is called spectrum sensing [43].

In FD-CRNs, the sensing and transmissions are carried out simultaneously on the same channel. Therefore, the spectrum sensing is not interrupted by the transmission of data. SUs can perform spectrum sensing at the PHY layer or the lower portion of the MAC layer which is referred to as the MAC sub-layer. The entire operation of spectrum sensing in FD-CRNs can be broadly classified into primary transmitter detection, primary receiver detection, and interference temperature management. The spectrum sensing in FD-CRNs is not limited to the space, time, and frequency domains. Other parameters and dimensions, such as the code dimension and the angle dimension, can also be included to widen the scope of spectrum sensing in FD-CRNs [43].

The spectrum sensing in FD-CRNs demands high sampling rates and high resolution as well as ADCs with large dynamic ranges and high-speed processing units, such as DSPs and FPGAs. The sensing frequency, which can be defined as the question “How often should the CR device perform the spectrum sensing?” is an important design issue in FD-CRNs. The IEEE 802.11 standard has proposed a sensing frequency of 30 seconds for HD-CRNs [43]. The RF components of FD-CRN should be configured or programmed such that they can not only sense a wide spectrum range but can also support the SIS approaches to gain a high throughput data rate compared to HD-CRNs as discussed in Section VI. Figure 7 shows our classification of the spectrum sensing approaches in FD-CRNs.

A. Cyclostationary Spectrum Sensing

The received signals are usually characterized using their periodicity or cyclostationarity. For this purpose, the spectral correlation factor is used to sense the signals [21]. In this spectrum sensing approach, the cyclostationary features

of the received signals are used to sense the spectrum. The cyclostationary-based spectrum sensing has been examined in FD capable LTE networks and WLANs with cognitive abilities in [96] to assess the impact of SI on the FD system performance. In particular, analog and digital active SIS has been considered and the detection probability has been evaluated. Cyclostationary spectrum sensing in OFDMA based FD-CRNs has been examined in [189]. In particular, the cyclic feature of the SU signals with their impact on the SIS approaches has been investigated by altering the cyclic prefix of the OFDMA signals.

B. Energy Detection-Based Sensing

The energy detection-based spectrum sensing is also referred to as radiometry or periodogram spectrum sensing [43]. Most of the hardware platforms for CRNs, such as GNU radios, universal software radio peripheral (USRP) software defined radios, and the shared spectrum radio from xG Technology Inc., use energy detection-based spectrum sensing to exploit the white space. Energy-detection based sensing is the most common form of spectrum sensing due to its low complexity and low computational overhead [43], [190]. Energy-detection based spectrum sensing in FD-CRNs can be categorized into cooperative and non-cooperative spectrum sensing as well as ON/OFF model based sensing.

1) *Cooperative Spectrum Sensing (CSS)*: In cooperative spectrum sensing (CSS), the information related to available spectrum resources is usually exchanged among the spectrum sensing nodes [191], [192]. The shared information is combined and then the spectrum decisions are made. The sensing results from the various nodes can be combined via selective combining, equal gain combining (EGC), and switch combining; and then either hard decisions or soft decisions are made to arrive at the final sensing decisions [43]. FD-CRNs support

CSS in either centralized or distributed fashion. In the centralized CSS approach, a central node acts as the BS and conducts the entire spectral decision making process. In the distributed CSS approach, the spectrum decisions are made by individual nodes.

a) Centralized CSS approach: To efficiently sense the spectrum, FD-CRNs can use a centralized CSS approach to address the various transmit imperfections. A centralized topology of cellular CRNs with FD capability has been considered in [124] for exploiting the available white space with the centralized CSS approach. In particular, the cooperative model of spectrum sensing is used and the transmit imperfections are addressed with the help of beamforming, while the SI has been addressed with the help of a passive propagation-based SIS approach. A CSS approach that supports robustness against malicious nodes in FD-CRNs has been studied in [181]. In this centralized topology, the CSS mitigates the SI and improves the detection probability and robustness against the misbehaving nodes. In particular, a confidence-only report rule and a weighted majority fusion rule have been used to achieve robustness while supporting the CSS [181].

b) Distributed CSS approach: A distributed CSS approach for FD-CRNs has been proposed and extensively evaluated in [104]. In particular, the distributed CSS approach operating with the LAT protocol has been evaluated. In this distributed CSS approach, the SUs had two antennas and used the digital SIS approach to mitigate the SI. The proposed scheme shows an improved performance in terms of throughput compared to the LBT protocol, i.e., the basic sensing approach that is used in traditional HD-CRNs with either centralized or distributed network topology.

Distributed CSS in FD enabled relaying CRNs has been analyzed in [160]. The distributed CSS approach helps in relaying unsuccessful PU packets and enhances the throughput of the primary as well as the secondary network. The analytical performance comparisons with HD-CRNs indicate that SUs as well as the PUs in FD-CRNs achieve increased throughput. A non-time slotted FD-CRN with CSS has been presented in [193]. In the non-time slotted FD-CRN, the PUs change their transmission behaviors randomly as compared to time-slotted FD-CRNs. The collision probability and the outage probability for the SUs have been analytically derived to show the effectiveness of the proposed scheme.

2) Non-Cooperative Spectrum Sensing: Energy-detection based spectrum sensing can also be performed in a non-cooperative way. The SUs with dedicated sensing periods in FD-CRNs can perform spectrum sensing by estimating the energy of the PU signals. In non-cooperative FD-CRNs, after gathering the sensing information, the messages are not broadcast to other SUs to make the collaborative spectral decisions [194]. We proceed to survey the area of non-cooperative spectrum sensing by giving overviews of selected approaches from the FD-CRN literature that illustrate the different operating modes, including non-time slotted, centralized, and distributed operation.

a) Non-time slotted spectrum sensing: Synchronization between the SUs to efficiently sense the spectrum and to transmit the data is an important design consideration for

FD-CRNs. Non-cooperative spectrum sensing has been used to achieve the synchronization between the SUs in a non-time slotted FD-CRN in [182]. The analytical evaluation of the proposed scheme shows the effectiveness of this spectrum sensing approach in combination with hybrid SIS. Another spectrum sensing approach for non-time slotted FD-CRNs has been introduced in [185]. In this energy-detection based spectrum sensing approach, multiple channels have been taken into consideration. The channel utilization of the multiple channels has been extensively analyzed with a non-cooperative spectrum sensing approach. SUs select a single channel from multiple channels with the help of a full-duplex spectrum sensing (FD-SS) approach that is based on non-cooperative spectrum sensing. The proposed scheme improves the throughput for PUs and maximizes the channel utilizations of SUs without requiring the synchronization between SUs and PUs.

b) Centralized spectrum sensing: Joint spectrum sensing and power allocation has been studied in [97]. This joint approach has been implemented in FD cellular CRNs with centralized network topology. The secondary base station (SBS) supports the FD operation by simultaneously sensing and transmitting in a centralized fashion. The problem of optimal power allocation to the SBS is formulated as the 3-dimensional matching problem and is then solved with the help of a 2-dimensional matching algorithm. In this approach, the power-throughput tradeoff is achieved and the energy-detection based spectrum sensing has been analyzed with respect to the cellular networks.

c) Distributed spectrum sensing: A non-cooperative spectrum sensing approach for decentralized FD-CRNs has been developed in [158]. In particular, the passive, analog, and digital SIS approaches have been used to mitigate the SI during the reception of sensing related signals. The proposed scheme reduces the packet loss ratio compared to HD-CRNs. Energy-detection based spectrum sensing has also been used to suppress the residual interference [101]. This spectrum sensing approach has been examined in a distributed network topology with propagation based SI suppression. A spectrum sensing approach can also be utilized for reducing the collision probabilities [14]. In this approach, the LAT protocol has been extended by introducing a decentralized dynamic spectrum access approach. The operation of this proposed protocol is similar to the dynamic spectrum access approach of HD-CRNs, except that it operates with FD-enabled SUs. For this purpose, PUs activity is modeled as the non-time slotted ON/OFF random process. The spectrum utilization, collision ratio with PUs, and optimal contention window size of HD-CRNs and FD-CRNs with dynamic spectrum access have been compared, giving favorable results for the examined FD-CRN approach. Cooperative FD-CRNs can also use energy-detection based spectrum sensing [184]. The SUs in this cooperative relaying approach forward the PU packets and achieve extra white space and bandwidth in return. The proposed spectrum sensing approach conserves energy and increases the throughput while supporting the decentralized network topology.

d) Hybrid centralized and distributed spectrum sensing: An energy-based spectrum sensing approach that can support

centralized as well as distributed network designs has been proposed in [19]. The spectrum sensing of traditional HD-CRNs and FD-CRNs have been compared and detailed analyses of energy-based spectrum sensing in FD-CRNs have been performed. This spectrum sensing approach considers a power-throughput tradeoff characterization to efficiently suppress the SI and to increase the throughput. This study has elaborated the design guidelines for spectrum sensing approaches for centralized and distributed FD-CRNs. A novel spectrum sensing approach for FD-CRNs has been proposed in [183]. In this approach, the probability of white space detection is derived, and from this probability, the overall channel utilization is estimated. The analytical and simulation results show that the proposed scheme improves performance compared to previous spectrum sensing approaches.

3) *ON/OFF Model Energy Sensing*: The energy-detection based spectrum sensing can also use an ON/OFF model (periodicity) for detecting the spectrum and exploiting the white space for transmission in FD-CRNs. This ON/OFF model approach of spectrum sensing has been introduced in [159]. In this approach, multiple antenna types have been used with a hybrid SIS approach. More specifically, in this FD-CRN, the $N \times M$ antenna types with the ON/OFF model of spectrum sensing suppress the SI with a hybrid approach. The spectrum sensing approach helps in reducing the collision probability and increasing the throughput compared to HD-CRNs.

An ON/OFF model energy-detection based spectrum sensing approach that supports frame fragmentation has been developed in [186]. Frame fragmentation in conjunction with the energy-based spectrum sensing not only helps in achieving QoS but also conserves energy by enhancing the probability of successful packet transmissions. The proposed spectrum sensing approach also supports a novel MAC protocol (see Section VIII-A).

An FD enabled LAT protocol has also been proposed with this periodic ON/OFF model of spectrum sensing [100]. In this approach, a separate antenna is employed to carry out the spectrum sensing. The antenna separation approach of SIS with energy-based spectrum detection in this LAT protocol achieves improved performance compared to the LBT protocol [100].

C. Waveform Based Sensing

The spectrum sensing can also be performed with the known PU activity patterns. The received signals are matched with the known PU activity patterns and the spectrum decisions are then made based on these known patterns. Spectral decisions based on these known PU signal patterns are termed as “waveform-based spectrum sensing”. In FD-CRNs, waveform-based spectrum sensing (according to the PUs signal patterns) has been utilized to make the sensing decisions in [187]. The transmission-reception-sensing strategy with respect to the waveform-based spectrum sensing has been analytically evaluated. The proposed scheme reduces the collision probability and increases the throughput. A waveform-based spectrum sensing approach with ON/OFF model has been proposed in [111]. In [111], the opportunistic spectrum access (OSA)

approach has been evaluated in a centralized FD-CRN topology. Specifically, the waveform-based spectrum sensing has been used with two antennas. The SI has been suppressed with a hybrid SIS approach.

D. Summary and Insights

In this section, we have provided a comprehensive survey of spectrum sensing approaches in FD-CRNs. The spectrum sensing approaches, such as energy-detection based sensing, waveform-based sensing, and cyclostationary-based sensing, can be used to sense the spectrum. The impact and performance of each spectrum sensing approach with respect to SIS have also been evaluated.

The energy-detection based spectrum sensing has been categorized into cooperative and non-cooperative and ON/OFF model-based spectrum sensing. In [124] and [181], the cooperative spectrum sensing with the centralized approach has been presented. Liao *et al.* [104] and ElAzzouni *et al.* [160], have provided the distributed cooperative spectrum sensing. The study in [158] has examined non-cooperative spectrum sensing with a hybrid SIS approach. The non-time slotted FD-CRNs [182], [185] have also been evaluated with energy-detection based spectrum sensing. Liao *et al.* [19] and Wang *et al.* [97] provide the power-throughput tradeoff for non-cooperative spectrum sensing in FD-CRNs. The ON/OFF model of spectrum sensing, which reduces collision probabilities in FD-CRNs, has been discussed in [159]. This model of spectrum sensing with frame fragmentation has been used in [186]. The LAT protocol with ON/OFF model of spectrum sensing has also been presented in [100]. The performance of waveform-based spectrum sensing in FD-CRNs has been evaluated in [187]. The OSA with waveform-based spectrum sensing has been discussed in [111]. The cyclostationary-based spectrum sensing [160] has been used in cognitive LTE and WLAN capable FD systems. In addition to the above mentioned approaches, a sliding window spectrum sensing approach [195] has also been proposed to minimize the access-latency. When the SUs do not leave the licensed band abruptly, they introduce the access-latency issue. For this purpose, the spectrum sensing decisions are taken on a sample-by-sample basis.

The majority of the research on spectrum sensing approaches in FD-CRNs to date has focused on energy-detection based spectrum sensing. However, there is a need to evaluate the performance of FD-CRNs with other spectrum sensing approaches, including approaches that consider the code and angle dimension of the white space spectrum. To the best of our knowledge, spectrum sensing approaches that ensure the security and secrecy of FD-CRNs have not been examined in detail to date. Also, the existing spectrum sensing approaches for FD-CRNs do not take the various PU activity patterns, such high, low, intermittent, and long PU activity [40], into consideration.

VIII. MAC PROTOCOLS FOR FULL-DUPLEX COGNITIVE RADIO NETWORKS

The underutilized or unused spectral resources can be efficiently utilized with the simultaneous sensing and transmission

TABLE III
COMPARATIVE VIEW OF MAC PROTOCOLS FOR FD-CRNs WITH THEIR MAJOR CONTRIBUTIONS, SIS APPROACHES,
AND SUPPORTED CRN ARCHITECTURE. ALL THE STUDIES CONSIDER THE PR ACTIVITY, EXCEPT [104]

Main category	References	Major Contribution	Performance Evaluation	Metrics Evaluated	SIS approach
Packet fragmentation based MAC protocols for FD-CRNs	[186]	Packet fragmentation with SI mitigation approach	Analytical and theoretical	QoS (Packet Drop), throughput, and energy efficiency	Considered
	[105]	Packet fragmentation with backoff mechanism	Simulation and analytical	Throughput with digital SIS	Digital SIS
Cooperative spectrum sensing based MAC protocols for FD-CRNs	[104]	Cooperative spectrum sensing based on the LAT	Simulation and analytical	Transmit power and throughput	Digital SIS
	[160]	Cooperative FD-CRNs with various numbers of PU and SU queues	Analytical	Throughput	Considered
Collision Reduction based MAC protocols for FD-CRNs	[14], [185]	Collision reduction between SUs of FD-CRNs	Simulation and analytical	Spectrum Utilization Ratio	Digital SIS
Full-duplex Cognitive MAC (FDC-MAC) protocols	[196]	Special-purpose FD-cognitive MAC; does not require any synchronization between SUs	Analytical	Throughput	Quality SIS
	[197], [199]	Adds capability to handle multiple channels to FDC-MAC protocol	Analytical	Throughput	Quality SIS

capability of FD-CRNs. For this purpose, FD medium access control (MAC) protocols have been designed to support high data rates with the increase of sensing and transmission time compared to MAC protocols for HD-CRNs [198]. MAC protocols for HD-CRNs have typically been based on the LBT protocol. The LBT MAC protocol senses the spectrum only in the first portion of a given time slot and then forward the data in the second portion. This limits the SU transmission time. Also, the limited sensing (only during the first portion of a time slot) can increase the probability of interference for PUs. Moreover, in these traditional HD-CRNs, MAC protocols could not efficiently detect collisions between SUs. When a collision between SUs occurs, the transmission continues. Therefore, the system performance greatly decreases with increasing collision probability and collision duration [91], [92]. Overall, this HD-CRN MAC protocol operation can result in inefficient spectrum sensing and transmission of data. In contrast, the MAC protocols for FD-CRNs can simultaneously sense the spectrum and transmit SU data.

We first briefly review a prominent FD-MAC protocol for general non-CR networks so as to help understand the design requirements for MAC protocols for FD-CRN networks. A MAC protocol for general FD (non-CR) networks has been proposed through three major modifications of the existing 802.11 MAC standard in [134]. The three major modifications are virtual backoffs, header snooping, and shared random backoffs. With the help of virtual backoffs, the packets in the buffers of access points (APs, or SUs in case of FD-CRNs) are prioritized. The AP with virtual backoffs selects the packets that are going to be served first and then triggers the FD operation according to the packet flow statistics. In header snooping, every packet that is to be transmitted is analyzed. Through this header snooping, the topology of the entire network is estimated. Then, depending on the network topology, the duplex mode (either FD or HD) is switched on. In shared random backoffs, any two nodes can discover that they have packets

to send at the same time. This can be achieved by adding the shared random backoff (SRB) field in the FD header. When the two nodes share the information about their packets, the FD operation can be optimized to minimize interference and collisions. These additions/modifications enable the FD-MAC to efficiently harness the available spectrum in a dynamic way as these approaches handle expected bottlenecks when the FD operation is employed. The FD-MAC has been practically implemented in [136] for a WiFi network (without CR). In this practical implementation of the FD-MAC, the theoretic doubling of throughput as compared to the HD-MAC has been achieved while using multiple channels.

Depending on the functionalities and contributions, the MAC protocol studies for FD-CRNs can be categorized into the main categories of MAC protocols based on packet fragmentation, cooperative spectrum sensing, collision reduction, and full-duplex cognitive operation, as summarized in Table III and surveyed in the following subsections. Table III provides a comparative view of the different MAC protocols for FD-CRNs.

A. Packet Fragmentation Based MAC Protocols for FD-CRNs

The unexpected appearance of PUs in CRNs can cease the SU transmission. This issue has been addressed by introducing packet fragmentation into the MAC layer of FD-CRNs in [186]. With the help of packet fragmentation, the entire packet is not dropped due to the unexpected interruption of the transmission. Another MAC protocol that can support the packet/frame fragmentation has been proposed in [105]. The standard backoff mechanism of the 802.11 MAC standard is used to resolve the contentions between the SUs during the packet fragmentation. The proposed protocol also takes the effective SIS and sensing overhead into consideration, and results in improved performance compared to the corresponding HD cognitive MAC protocol [105].

B. Cooperative Spectrum Sensing Based MAC Protocols for FD-CRNs

MAC protocols for LAT-based cooperative spectrum sensing (CSS) have been examined in [104]. The theoretical doubling of the throughput is achieved in this approach when the secondary power is optimally controlled. In particular, the CSS-based LAT outperforms the LBT only when the secondary power is very low. The study [104] provided a throughput-power tradeoff and protocol design paradigm for setting the optimal secondary power that enhances the FD-CRN throughput. A MAC layer with an error free ACK/NACK packet has been examined in [160] for SUs in cooperative CRNs with FD capability. In the considered cooperative FD-CRN, a MAC layer with the error-free ACK/NACK packet is used for decoding the PU activity packets. Different queues for the SUs and PUs are introduced for achieving the cooperation between the SUs and PUs. The synchronization between the SUs and PUs in this case is well achieved compared to HD-CRNs.

C. Collision Reduction Based MAC Protocols for FD-CRNs

Collisions between SUs and collision durations can be reduced through the FD capability in CRNs. For this purpose, a novel MAC protocol that estimates the collision ratio with PUs, spectrum usage ratio, and optimal contention window size has been proposed in [14]. Due to continuous sensing of the PUs' idle and active states by the SUs, SUs can make intelligent decisions, and select only those channels that are idle. The resulting extended version of the LAT protocol reduces collision while supporting FD-CRN communication with decentralized dynamic spectrum access.

To achieve synchronization between PUs and SUs in non-time slotted CRNs, a MAC protocol for non-time slotted FD-CRNs has been proposed in [185]. This full-duplex cognitive medium access control (FDC-MAC) can support multiple channels in non-time slotted CRNs. With the multi-channel capability, the collisions and the backoff stages are minimized to support the FD operation. For minimizing collisions and to enhance the throughput of the primary network, SUs in this approach sense the re-activation of PUs on a channel in a timely manner through a full-duplex spectrum sensing (FD-SS) approach.

D. Full-Duplex Cognitive MAC (FDC-MAC) Protocols

The full-duplex cognitive MAC (FDC-MAC) protocol proposed in [196] does not require any synchronization between the SUs. The entire operation of the FDC-MAC has been divided into two stages. In the first stage, the SUs with FD capability perform the channel contention operation, followed by the spectrum sensing and transmissions in the second stage.

Full-duplex cognitive MAC protocols have been proposed in [197] and [199]. In particular, a full-duplex multi-channel MAC protocol for multi-hop CR networks has been proposed in [199]. The multi-channel setting gives the SUs more flexibility for finding idle channels for transmissions, i.e., SUs do

not have to wait for any specific channel to become free. In the MAC protocol in [199], a node with data to transfer selects one of the idle channels as its own home channel (Hch). Both the sending and receiving nodes tune their receiving antennas to the Hch (idle frequency band) and then forward the data on that channel. The proposed protocol has the capability to operate with and without a common control channel. The performance of the proposed FD-MAC protocol has been compared with the IEEE 802.11 standard with DCF mode and the proposed scheme outperforms the IEEE 802.11 DCF by a factor of 20.

A multichannel full-duplex cognitive MAC (MFDC-MAC) protocol that takes into consideration load-balancing has been developed in [197]. Randomized dynamic channel selection is used to select a single channel for spectrum sensing and transmission, while the contention issue is addressed with the help of a standard backoff mechanism. The study [197] demonstrates that the introduction of multiple channels in FDC-MAC enhances not only the sensing and transmission performance but aids also in load-balancing.

E. Summary and Insights

In this section, we have surveyed the MAC protocols for FD-CRNs. The MAC protocols for FD-CRNs have been designed to support the simultaneous sensing and transmission on the same channel. MAC protocols for FD-CRNs have been designed to tackle the various MAC issues, such as hidden terminals, packet loss ratio (PLR), bit error rate (BER), and end-to-end delay. The collision probability has also been decreased with the FD-CRNs compared to traditional HD-CRNs. However, the various PR activity patterns, such as high, low, intermittent, and long PR activity, have not yet been considered for FD-CRN MAC protocols. Security and privacy issues for PUs and SUs have also not yet been considered.

SIS approaches have been considered extensively in the design of MAC protocols for FD-CRNs. In [105] and [186], the packet and frame fragmentation capability has been added in the MAC protocol to support the FD operation in CRNs. Packet drops due to unexpected transmission interruptions have been minimized with packet fragmentation. An FD-CRN MAC protocol with cooperative spectrum sensing has been examined in [104]. Various queues for PUs and SUs in cooperative FD-CRNs have been studied in [160]. In [14], collisions between SUs and PUs have been minimized with the help of modifications of the 802.11 MAC standard. The synchronization of SUs and PUs in non-time slotted FD-CRNs has been achieved with the FD-enabled MAC in [185]. A specific-purpose MAC protocol for FD-CRNs, referred to as FDC-MAC has been presented in [196] and [197]

MAC protocols for FD-CRNs that can support energy harvesting approaches or wireless power transfer have not yet been proposed and present an important area for future research. Overall, the existing research on MAC protocols for FD-CRNs has only considered a very limited range of link layer metrics. There is an urgent need to evaluate FD-CRN MAC protocols for a wide range of link layer metrics and

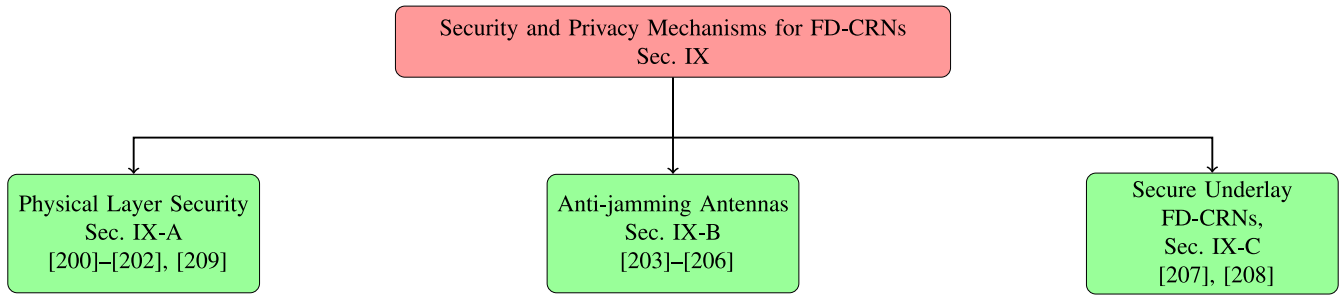

Fig. 8. Physical layer security, anti-jamming antennas, and secure underlay communication can secure FD-CRNs against various threats.

scenarios, including packet loss ratio (PLRs) and bit-error-rate (BER), as well as varying degrees of the hidden terminal problem.

IX. SECURITY AND PRIVACY IN FD-CRNs

In CRNs, the licensed and unlicensed users coexist in the same network, which can result in the breach of primary network security. Confidential data can be compromised due to the presence of malicious SU or PU nodes [52]. The existing work on the security of FD-CRNs has considered physical layer security, dedicated anti-jamming antennas, as well as secure underlay and relay networks, as categorized in Figure 8.

A. Physical Layer Security in FD-CRNs

To mitigate the impact of eavesdroppers in wireless powered FD-CRNs, the study in [200] takes into consideration the physical layer security in underlay FD-CRNs. In this approach, the destination node is equipped with two antennas for simultaneous transmission and reception. The receiving antenna not only receives the information but also receives the energy packets.

More specifically, in the examined wireless powered FD-CRN, the receiving antenna is used for receiving the energy packets from the power splitter. Then the received energy is exploited by the transmitting antenna for the transmission of jamming signals. These jamming signals are used to counter the malicious attacks from various intruders. The physical layer security approach for FD communication has been further examined in a few studies, including studies on simple relaying [201] and multihop relaying [209]. Physical layer security with SIS approaches has been examined in [202].

B. Anti-Jamming Antennas in FD-CRNs

To overcome the security issues in primary networks, a dual antenna selection scheme for FD-CRNs has been proposed in [203]. Through the FD approach, the SUs can alternatively select either the transmission antenna or the jamming antenna. The transmission antenna supports the transmission of data, while the jamming antenna produces the jamming signals to counter the impact of eavesdroppers so as to secure the primary and secondary networks. This approach results in transmission gains for the secondary network and enhances the security of the primary network.

An anti-jamming FD-CRN receiver has been proposed in [204]. In particular, the impact of the local oscillator

phase noise has been investigated and the performance of the proposed anti-jamming FD-CRN receiver has been compared with HD-CRNs. In the proposed receiver, the SI is suppressed with a digital SIS approach. The interference signal to noise ratio (INR) for energy detection-based interference sensing is calculated with phase noise for a fading channel. The proposed FD-CRN receiver achieves performance improvements over HD-CRNs while taking the detection probability and false-alarm probability into consideration. The proposed receiver appears well suited for military and other security applications.

Wiretap networks are networks whose communications are tapped by a third party, or that can support the tapping of conversations by a third party for security purposes. The security and privacy in cognitive wiretap networks have been discussed in [205]. In particular, multi-antenna wiretap networks with SUs and FD capability have been considered. In order to counter the impact of eavesdroppers, two jamming schemes, namely selection combining/selection jammer (SC/SJ) and SC/Zero forcing beamforming (SC/ZFB), have been proposed to minimize the quality of the eavesdropper signals. The jamming signals in cognitive wiretap networks can be simultaneously transmitted by the receiving SUs with FD capability [206]. Random selection combining (RSC) and generalized selection combining (GSC) have been proposed as the general antenna reception approaches for the full-duplex SUs. The exact closed-form expression for the security outage probability has been derived while taking into consideration the multi-antenna wiretap network setting.

C. Secure Underlay-Based FD-CRNs

Secure underlay FD-CRN communication has been studied in [208]. In the underlay mode, the SUs transmit simultaneously with the PUs to overcome the spectrum scarcity. In some cases, the PUs can be the potential threat or eavesdropper. This threat can be minimized while equipping the SUs with FD antennas. The FD SUs broadcast jamming signals that eventually minimize the impact of the eavesdropper. Through this secure FD-CRN communication, the QoS is ensured not only for the PUs but also for the secondary networks.

Secure FD communication in cognitive small cells networks has been proposed in [207]. For securing the PU and SU communication, three different relay selection schemes, namely partial relay selection, optimal relay selection, and minimal SI relay selection, have been proposed [207]. Using the optimal

relay selection and increasing the number of cognitive small-cell base stations can increase the security of the primary and secondary networks.

D. Summary and Insights

In this section, we have surveyed the existing work on security and secrecy issues in FD-CRNs. To the best of our knowledge, very limited work on the security and privacy issued in FD-CRNs has been done so far. Generally, CRNs are exposed to various security threats [53], [54], [57]; therefore, FD-CRNs also need to be protected against potential threats.

The existing work on the security of FD-CRNs discusses the dual antenna selection approach to mitigate the potential threat by simultaneously transmitting data and jamming signals [203]. To secure wireless-powered FD-CRNs, energy packets can be simultaneously processed with jamming packets to secure the wireless powered FD cognitive communication. Anti-jamming antennas have been especially developed to not only minimize the phase noise but also to minimize the eavesdropper impact [204]. Secure FD cognitive small cell communication that takes eavesdroppers from the primary network into consideration has been examined in [207]. Underlay FD-CRNs with secure SU communication in which the PUs act as eavesdroppers have been presented in [208]. Multi-antenna cognitive wiretap networks with FD antennas have been made secure by implementing selection combining/selection jamming (SC/SJ) and SC/Zero forcing beamforming (SC/ZFB) [205], [206].

The existing work on securing the FD-CRNs has considered the physical layer security with dedicated anti-jamming antennas to avoid eavesdroppers. However, the wide range of specific CRN security and privacy threats, such as primary user emulation (PUE) attacks [56], denial-of-service attacks [210], and spectrum sensing data falsification (SSDF) attacks [211], need to be studied from the FD-CRN perspective, taking the spectrum sensing and SIS approaches into consideration. Furthermore, in FD-CRNs with a common control channel, e.g., [211], security strategies for this crucial common control channel need to be developed and evaluated.

X. STANDARDIZATION, SIMULATION TOOLS, PERFORMANCE METRICS, AND HARDWARE PLATFORMS FOR FD-CRNs

A. Standardization

1) *CRN Standardization*: Standardization bodies around the world have introduced CRN standards to bridge the gaps between the research domain, industry, and real deployments. The first standard for CRNs is the IEEE 802.22 wireless regional area network (WRANs) standard [66], [70]. This standard empowers the CR-enabled devices to use the television (TV) broadcast band or the TV whitespace (TVWS). The IEEE 802.22 WRAN standard paves the way for rural users to exploit the TVWS on a non-interfering basis.

The IEEE 1900.6 standard encompasses the spectrum sensing interfaces and provides guidelines for DSA data structures. The applicability of the IEEE 1900.6 standard in different network scenarios and its interoperability with other standards

TABLE IV
SIMULATION TOOLS USED FOR EVALUATING
THE PERFORMANCE OF FD-CRNs

Simulation Method	Tool or Paper
Labview	[173]
Mathematica	[217]
Matlab	[3], [112], [113], [167], [203], [218], [219]
Monte Carlo technique	[73], [95], [98], [121], [194], [195], [200], [207], [220], [221]

have also been examined from various perspectives, such as adaptive reconfigurability, channel capacity, and channel availability [68]. The IEEE 1900.6 standard also addresses the DSS by various wireless devices in heterogeneous wireless communication ecosystems.

Extensive effort has already been put into the standardization of the TVWS [212]. The IEEE 802.19.1 standard has been proposed for the coexistence of unlicensed users within the TVWS [213], [214]. This standard allows the various radio technologies to coexist within the TVWS formed by the different TV band networks.

2) *FD Standardization*: FD was first endorsed in the IEEE 802.3 standard in 1997 with the IEEE 802.3x-1997 and 802.3y-1997 standard supplements [215]. All the necessary modifications were made in the existing IEEE 802.3 standard for the provision of the FD capability. In the IEEE 802.3x-1997 standard, all the major modifications at the MAC and the PHY layer are made with a pause-based flow control mechanism to support the simultaneous transmission and reception. In the IEEE 802.3y-1997 standard, the modifications in 100BASE-T are made to support the FD operation. Modifications of other standards so as to add FD capabilities have been explored. For example, the potential of using the IEEE.802.15.4a ultra-wideband communication (UWB) standard for FD communications has been explored in [216]. Collision free FD communication with respect to energy-efficiency and reliability have also been investigated in [216].

3) *FD-CRN Standardization*: The standardization of FD-CRNs is in the stage of infancy. The nascent field of FD-CRNs has yet to be standardized to bridge the gap between the research results and practical implementations. In light of the potential benefits of FD-CRNs, it is expected that FD-CRNs will soon be standardized.

B. Simulation Tools for FD-CRNs

The three main simulating tools employed for simulating FD-CRNs are LabView, Mathematica, and MATLAB (see Table IV). Moreover, several studies have employed the Monte Carlo simulation technique (see Table IV).

There is also need to consider collisions, contention, and hidden terminal problems in detail in the evaluation of FD-CRN MAC protocols. Moreover, the MAC protocols that have been devised to date for FD-CRNs have not yet been evaluated in more realistic simulators, such NS-2 or NS-3, see Section VIII and Table III. Thus, the rigorous evaluation of FD-CRN MAC protocols using advanced simulation tools is an important direction for future research.

TABLE V
PERFORMANCE METRICS USED FOR EVALUATING
THE PERFORMANCE OF FD-CRNs

Metrics	References
Sum capacity	[176]
Throughput	[19], [100], [104], [105], [111], [123], [160], [182], [186], [193]
Rate Region	[99], [124]
Outage probability	[98], [120], [203], [218], [220], [222]
SNR	[109], [121], [196]
Collision probability	[159], [187]
Packet loss	[158]
Power allocation	[157]
Energy detection	[101]
Energy-Efficiency	[184]
QoS	[112]
Detection probability	[96], [181]
Channel utilization	[185]

C. Performance Metrics for FD-CRNs

In Table V, we summarize the performance metrics considered in FD-CRN studies. Most of the work on FD-CRNs has evaluated the operation of FD-CRNs with respect to throughput and outage probability. Future work should expand the scope of examined FD-CRNs performance metrics to give a more comprehensive evaluation, e.g., by examining the SNR, SINR, packet loss, QoS, detection probability, and PR activity.

D. Hardware Platforms and Prototypes for FD-CRNs

A first practical study of FD-CRNs using the existing architecture of CRNs and FD radios has been carried out in [99]. Directional multi-reconfigurable antennas have been employed for simultaneous sensing and transmission while exploiting the white space. The resulting SI has been mitigated with the help of a hybrid SIS approach. The characterization of the range rate shows that FD-CRNs outperform HD-CRNs [99].

Direct-conversion radio transceivers are usually used as the hardware solution for FD-CRNs. However, the direct-conversion radio transceiver hardware platforms have several imperfections, such as in-phase and quadrature imbalance (IQI). To address these imperfections, the study [108] first quantified the effect of IQI on the spectrum sensing approach. Then, closed-form expressions have been derived for the false alarm and detection probabilities, and finally the IQI has been considered in the SIS.

General radio hardware platforms, such as the universal software radio peripheral (USRP), have also been extended to support the operation of the FD-CRNs. An OSA approach using the USRP platform has been examined in [173]. Specialized hardware circuits have also been designed to evaluate the impact of FD-CRNs. For instance, the 1-tap cancellation circuit has been used in [223] to evaluate the digitally controlled analog SIS approach for in-device spectrum sharing and aggregation. A novel SDR platform for implementing FD-WiFi networks referred to as GRT-duplex has also been proposed [224]. GRT-duplex can support different spectrum sensing and SIS approaches for FD-CRNs. A similar SDR implementation has recently been presented in [225].

TABLE VI
SUMMARY OF PR ACTIVITY MODELS CONSIDERED IN FD-CRN STUDIES

PR activity model	Paper
ON/OFF model (idle/busy)	[14], [105], [108], [158], [160], [170], [182], [186], [193]–[197]
Unknown PR Activity	[219]

XI. OPEN ISSUES, CHALLENGES, AND FUTURE RESEARCH DIRECTIONS

A. Spectrum Related Issues and Research Directions

1) *Spectrum Sensing*: Shadowing or multipath fading can cause various MAC layer issues, such as hidden terminals [13]. These issues can be resolved with the help of cooperative spectrum sensing (CSS), which generally increases the sensing performance. However, CSS needs extra resources to effectively sense the spectrum. To address this issue, non-cooperative spectrum sensing has been proposed for FD-CRNs.

The existing spectrum sensing research has extensively considered FD-CRN spectrum sensing based on energy-detection. In contrast, cyclostationary and waveform-based spectrum sensing still need to be further explored along the various SIS and security dimensions.

Spectrum sensing approaches for FD-CRNs have been proposed while taking into consideration the time, frequency, and space dimensions. There is also need to further explore the various spectrum sensing approaches for other white space dimensions, such as the code and angle dimensions [11]. Moreover, the behaviors of spectrum sensing approaches in the presence of eavesdroppers and other security threats have yet to be explored for FD-CRNs.

2) *Spectrum Sharing*: Dynamic spectrum sharing is the basic tenet of CRNs. The uninterrupted spectrum sensing in FD-CRNs greatly improves the efficiency of spectrum sharing in FD-CRNs compared to HD-CRNs [119], [226]. Most of the existing work on spectrum sharing in FD-CRNs has considered relay networks. However, spectrum sharing with respect to overlay networks, multihop networks, and fading environments in FD-CRNs has yet to be explored and presents important future research directions.

3) *Spectrum Mobility*: The SUs in CRNs can use a licensed band as long as PUs are not using the band. When a PU arrives, the SUs have to vacate the band. This spectrum mobility has been extensively examined for HD-CRNs. However, for FD-CRNs, the issues arising from spectrum mobility have not yet been explored in detail and there are several important open research directions. For instance, PU node mobility, i.e., changes in the physical locations of PU nodes, may change the channel set available to SUs. Similarly, SU node mobility may change the channel set available in the vicinity of the SU node. Considering the PU and SU node mobility may be an interesting direction for studying the CR spectrum mobility.

B. MAC Layer Research Directions

The MAC protocols for FD-CRNs that have been studied to date take packet fragmentation into consideration, minimize the collision probability, and improve the sensing performance

with the help of dedicated sensing and transmitting antennas, see Section VIII and [14], [104], [105], [160], and [186]. However, the various MAC layer issues, such as the hidden terminal problem as well as potentially high bit error rates (BERs) and packet-loss ratios (PLRs), have yet to be examined in detail in the context of FD-CRNs.

The PLR can be reduced with the provisioning of larger buffers. The theoretical doubling of the throughput in FD-CRNs can be enhanced by efficiently suppressing the SI and reducing the BER at the MAC layer. Extensive research on appropriately sizing the buffers and minimizing the BER at the MAC layer is needed.

Another interesting direction for future MAC layer research is to examine and optimize the interactions between MAC protocols in FD-CRNs and the various access and metropolitan area networks that support the backhaul from wireless FD-CRNs. For instance, so-called fiber-wireless (FiWi) networks [227], [228] consider the cooperation between wireless networks and optical fiber networks that support the wireless network operation. Commonly, the optical networks that support wireless networks have specific bandwidth allocation and MAC protocols [229]–[233], that can be jointly examined with the FD-CRN MAC protocols. Similarly, an end-to-end network connection involving an FD-CRN may traverse other common access networks, such as coax cable and digital subscriber line (DSL) based networks [234]–[237] or specific metropolitan area network structures [238]–[242], whose characteristics may be exploited for overall optimized MAC across the networks traversed by end-to-end flows.

C. Routing Layer Research Directions

Routing protocols play an important role in selecting the shortest paths while conserving energy and other resources in CRNs [47], [48]. FD-CRN routing protocols should select short and energy-conserving paths while supporting the simultaneous sensing and transmission operations. To the best of our knowledge, FD-CRN routing has so far only been examined in an initial study on routing with self-interference suppression in [243]. FD-CRN routing protocols thus present a wide open area for future research. For instance, there is a need to study the impact of different routing metrics in FD-CRNs. Similarly, proactive and reactive routing protocols for multi-hop FD-CRNs need to be investigated.

D. PU Activity

CRNs operate while considering the various PU activity patterns. PUs, which may be also referred to as primary radios (PRs), follow the high, low, long, and intermittent activity patterns [40], [244]. Several studies, such as [14], [105], [160], [186], have considered the PU activity in FD-CRNs. However, most of the existing FD-CRN studies consider only the ON/OFF PU activity model, while the study [219] considers FD spectrum sensing with unknown PU activity, as summarized in Table VI. FD-CRN MAC protocols and routing protocols as well as spectrum sensing and SIS approaches can become more efficient when considering the various PU activity patterns. Moreover, PU activity data collected from

real spectrum measurement campaigns can serve as a basis for studies to further enhance the underlying performance of FD-CRNs.

E. Security and Privacy

In FD-CRNs, the SUs can simultaneously sense the spectrum and transmit jamming signals to mitigate the impact of eavesdroppers. However, various CRNs related threats, such as primary user emulation (PUE) attacks [56] and others, as discussed in [58], have not been analyzed for FD-CRNs. Also, the impacts of spectrum sensing approaches on the security threats in FD-CRNs have yet to be examined in detail. The physical layer security in FD-CRNs still needs to be further explored while covering the overlay, underlay, and interweave operational modes of FD-CRNs [11].

F. Energy Harvesting and Green Communications

Through different energy harvesting approaches, such as simultaneous wireless information and power transfer (SWIPT) [245], wireless communication can be made energy-efficient. CRNs, especially cognitive radio sensor networks (CRSNs) [246], can greatly benefit from energy harvesting approaches [247]. In FD-CRNs, the dedicated sensing and transmission antennas require more energy compared to HD systems. Efficient energy management and conservation approaches are therefore especially important for FD-CRNs. Energy harvesting is one promising approach for judicious energy management in FD-CRNs [248], [249]. Wireless-powered SUs with FD capability have been explored in [200]. However, there are plentiful future work opportunities in the area of energy harvesting FD-CRNs.

Energy conservation is an important research domain in wireless communications [60], [62], [250]. CRNs have also been designed to support green communication while conserving energy during the exploitation of the licensed band [60], [62]. The simultaneous sensing and transmission of signals in FD-CRNs is highly energy demanding; therefore the green communications is highly important for FD-CRNs. To the best of our knowledge there are no detailed studies yet on the green communication in the context of FD-CRNs.

G. Polarization and Beamforming

Polarization [251] and beamforming approaches can suppress the SI and improve the FD communication performance compared to HD systems [13], [252]. Since each link in FD communication (as in bidirectional full-duplex (BFD) [253]) forms beams, an increased sum rate with minimized SI can be achieved with FD communication [13]. However, the polarization and beamforming approaches have not yet been investigated in detail with respect to FD-CRNs. Only the study [124] has taken beamforming into consideration for mitigating the SI in FD-CRNs. SIS and spectrum sensing approaches that exploit beamforming and polarization present promising future FD-CRN research directions.

H. Self-Interference Suppression (SIS)

Channel state information (CSI) is not only used for resource allocation but also for mitigating the SI in FD wireless communications [87]. However, to date, the CSI has not yet been taken into consideration for suppressing the SI in FD-CRNs. The leakage due to the transmit chain impairments also contributes to the SI in FD-CRNs [19]. Therefore, there is a need to suppress the SI resulting from the different transmit chain leakages in FD-CRNs.

When effective SIS can not be achieved, then the so-called “virtual-full-duplex” approach [254]–[256] can be used. The virtual-full-duplex approach consists of a set of signaling schemes that gradually turn the full-duplex operation at the MAC layer on and off, while using HD operation at the physical layer. To the best of our knowledge, the virtual-full-duplex operation for FD-CRNs has yet to be considered for SI mitigation.

I. Network Coding

Physical layer network coding (PLNC) in FD-CRN relay networks with DF relaying has been examined in [217]. Generally, there is a need to further explore NC in CRNs, including CRNs with FD capability [257], [258]. Network coding can generally increase the reliability in chaotic and unreliable communication settings [259]–[265] and has thus great potential for enhancing both HD and FD CRNs. For instance, the AF relaying mode should be examined for FD-CRNs with respect to NC. In addition, SIS approaches, spectrum sensing, and radio resource allocation in conjunction with NC need further work in FD-CRNs. Moreover, network coding-OFDM (NC-OFDM)-based networks have been analyzed for HD-CRNs [266]. Future research needs to examine the corresponding NC-OFDM-based FD-CRNs.

J. Support of Heterogeneous Applications

CRNs can support a wide range of heterogeneous applications, such as wireless medical telemetry and delay sensitive multimedia applications [76]. However, FD-CRNs have not yet been extensively studied from the perspective of supporting a diverse range of applications. Delay-sensitive and bandwidth-hungry multimedia applications require extensive spectrum and network resources. FD-CRNs can provide seamless connectivity for these time-critical applications without interruption. Therefore, FD-CRNs should also be studied from the perspective of multimedia and other heterogeneous applications, while evaluating a range of different performance evaluation metrics, such as QoS and quality-of-experience (QoE).

K. Softwarization and Virtualization in FD-CRNs

Network virtualization allows multiple virtual networks to operate over a given single physical network [267]–[270]. Network virtualization has found its way into the field of CRNs [52], [271]–[273]. Network virtualization is often facilitated by softwarizing the network control through software defined networking (SDN) [274]–[281]. However, the virtualization of FD-CRNs has not yet been proposed. There is a

need to virtualize the FD operation of the SUs. The virtualization has the potential to ultimately enhance the spectrum utilization. The SIS in FD-CRNs could also be addressed by properly virtualizing the FD-CRN communication.

L. Standardization for FD-CRNs

Standards for CRNs [66]–[68], [70], [212] and FD communication [215] have already been proposed. To bridge the gap between research findings and practical implementations, standards for FD-CRNs are needed. To implement FD-CRNs in different network topologies with different network operators, the FD-CRN communication mode needs to be standardized. However, such FD-CRN standards have yet to be proposed and are an important direction for future work.

XII. CONCLUSION

Simultaneous sensing and transmission on the licensed bands with the help of full-duplex cognitive radio networks (FD-CRNs) can enhance the throughput. The interference to primary users (PUs) caused by the limited sensing time in conventional half-duplex (HD) CRNs can be minimized with the continuous sensing in FD-CRNs. The self-interference (SI) during the full-duplex (FD) operation in CRNs has been minimized through passive, active, or hybrid self-interference suppression (SIS) approaches. In this article, we have provided an up-to-date survey of research on FD-CRNs. We have comprehensively covered all aspects and dimensions of FD-CRNs, including SIS approaches. Five case studies have also been presented that illustrate the applicability of FD-CRNs. We have classified FD-CRN architectures according to the underlying CR operation into underlay, overlay, and interweave FD-CRNs. We have then covered the FD-CRN radio aspects, including the different antenna designs, antenna pairings, and transmission modes. Spectrum sensing in FD-CRNs has also been surveyed with a classification into cyclostationary, energy-detection based, and waveform based approaches. We have surveyed the redesign efforts to adapt existing CRN MAC protocols to support the FD operation. We have also provided details about the work on security and privacy in FD-CRNs. We then have concluded our survey with outlines of open issues, challenges, and future research directions.

REFERENCES

- [1] “Cisco visual networking index: Global mobile data traffic forecast update 2014–2019 white paper,” Cisco, Inc., and Visual Netw. Index, San Jose, CA, USA, Feb. 2015. [Online]. Available: http://www.cisco.com/c/en/us/solutions/collateral/service-provider/visual-networking-index-vni/white_paper_c11-520862.html
- [2] V. Chandrasekhar, J. G. Andrews, and A. Gatherer, “Femtocell networks: A survey,” *IEEE Commun. Mag.*, vol. 46, no. 9, pp. 59–67, Sep. 2008.
- [3] M. Feng, S. Mao, and T. Jiang, “Duplex mode selection and channel allocation for full-duplex cognitive femtocell networks,” in *Proc. IEEE Wireless Commun. Netw. Conf. (WCNC)*, New Orleans, LA, USA, 2015, pp. 1900–1905.
- [4] T. S. Rappaport *et al.*, “Millimeter wave mobile communications for 5G cellular: It will work!” *IEEE Access*, vol. 1, pp. 335–349, 2013.
- [5] D. Bharadia and S. Katti, “Full duplex MIMO radios,” in *Proc. USENIX Conf. Netw. Syst. Design Implement. (NSDI)*, Seattle, WA, USA, 2014, pp. 359–372.

- [6] R. Sultan, L. M. Song, K. G. Seddik, and Z. Han, "Full-duplex meets multiuser MIMO: Comparisons and analysis," *IEEE Trans. Veh. Technol.*, vol. 66, no. 1, pp. 455–467, Jan. 2017.
- [7] K. G. Shin, H. Kim, A. W. Min, and A. Kumar, "Cognitive radios for dynamic spectrum access: From concept to reality," *IEEE Wireless Commun. Mag.*, vol. 17, no. 6, pp. 64–74, Dec. 2010.
- [8] S. Bhattarai, J.-M. J. Park, B. Gao, K. Bian, and W. Lehr, "An overview of dynamic spectrum sharing: Ongoing initiatives, challenges, and a roadmap for future research," *IEEE Trans. Cogn. Commun. Netw.*, vol. 2, no. 2, pp. 110–128, Jun. 2016.
- [9] B. Rashid, M. H. Rehmani, and A. Ahmad, "Broadcasting strategies for cognitive radio networks: Taxonomy, issues, and open challenges," *Comput. Elect. Eng.*, vol. 52, pp. 349–361, May 2016.
- [10] I. F. Akyildiz, W.-Y. Lee, M. C. Vuran, and S. Mohanty, "NeXt generation/dynamic spectrum access/cognitive radio wireless networks: A survey," *Comput. Netw.*, vol. 50, no. 13, pp. 2127–2159, 2006.
- [11] F. Akhtar, M. H. Rehmani, and M. Reisslein, "White space: Definitional perspectives and their role in exploiting spectrum opportunities," *Telecommun. Policy*, vol. 40, no. 4, pp. 319–331, 2016.
- [12] O. Holland, "Some are born with white space, some achieve white space, and some have white space thrust upon them," *IEEE Trans. Cogn. Commun. Netw.*, vol. 2, no. 2, pp. 178–193, Jun. 2016.
- [13] D. Kim, H. Lee, and D. Hong, "A survey of in-band full-duplex transmission: From the perspective of PHY and MAC layers," *IEEE Commun. Surveys Tuts.*, vol. 17, no. 4, pp. 2017–2046, 4th Quart., 2015.
- [14] Y. Liao, T. Wang, K. Bian, L. Song, and Z. Han, "Decentralized dynamic spectrum access in full-duplex cognitive radio networks," in *Proc. IEEE Int. Conf. Commun.*, London, U.K., 2015, pp. 7552–7557.
- [15] G. Liu, F. R. Yu, H. Ji, V. C. M. Leung, and X. Li, "In-band full-duplex relaying: A survey, research issues and challenges," *IEEE Commun. Surveys Tuts.*, vol. 17, no. 2, pp. 500–524, 2nd Quart., 2015.
- [16] G. Prasad and L. Lampe, "Full-duplex spectrum sensing in broadband power line communications," in *Proc. IEEE Int. Symp. Power Line Commun. Appl. (ISPLC)*, Madrid, Spain, 2017, pp. 1–6.
- [17] L. Song, R. Wichman, Y. Li, and Z. Han, *Full-Duplex Communications and Networks*. New York, NY, USA: Cambridge Univ. Press, 2017.
- [18] M. E. Knox, "Single antenna full duplex communications using a common carrier," in *Proc. Annu. Wireless Microw. Technol. Conf.*, Cocoa Beach, FL, USA, 2012, pp. 1–6.
- [19] Y. Liao, L. Song, Z. Han, and Y. Li, "Full duplex cognitive radio: A new design paradigm for enhancing spectrum usage," *IEEE Commun. Mag.*, vol. 53, no. 5, pp. 138–145, May 2015.
- [20] H. Yu, Y. Sung, and Y. H. Lee, "Superposition data transmission for cognitive radios: Performance and algorithms," in *Proc. IEEE Mil. Commun. Conf.*, San Diego, CA, USA, 2008, pp. 1–6.
- [21] I. F. Akyildiz, W. Y. L. Lee, M. C. Vuran, and S. Mohanty, "A survey on spectrum management in cognitive radio networks," *IEEE Commun. Mag.*, vol. 46, no. 4, pp. 40–48, Apr. 2008.
- [22] A. Ali and W. Hamouda, "Advances on spectrum sensing for cognitive radio networks: Theory and applications," *IEEE Commun. Surveys Tuts.*, vol. 19, no. 2, pp. 1277–1304, 2nd Quart., 2017.
- [23] E. Axell, G. Leus, E. G. Larsson, and H. V. Poor, "Spectrum sensing for cognitive radio: State-of-the-art and recent advances," *IEEE Signal Process. Mag.*, vol. 29, no. 3, pp. 101–116, May 2012.
- [24] D. Datla, A. M. Wyglinski, and G. J. Minden, "A spectrum surveying framework for dynamic spectrum access networks," *IEEE Trans. Veh. Technol.*, vol. 58, no. 8, pp. 4158–4168, Oct. 2009.
- [25] H. Ding *et al.*, "Cognitive capacity harvesting networks: Architectural evolution towards future cognitive radio networks," *IEEE Commun. Surveys Tuts.*, to be published.
- [26] C. Ghosh, S. Pagadarai, D. P. Agrawal, and A. M. Wyglinski, "A framework for statistical wireless spectrum occupancy modeling," *IEEE Trans. Wireless Commun.*, vol. 9, no. 1, pp. 38–44, Jan. 2010.
- [27] A. Goldsmith, S. A. Jafar, I. Maric, and S. Srinivasa, "Breaking spectrum gridlock with cognitive radios: An information theoretic perspective," *Proc. IEEE*, vol. 97, no. 5, pp. 894–914, May 2009.
- [28] A. Ghasemi and E. S. Sousa, "Fundamental limits of spectrum-sharing in fading environments," *IEEE Trans. Wireless Commun.*, vol. 6, no. 2, pp. 649–658, Feb. 2007.
- [29] S. Haykin, D. J. Thomson, and J. H. Reed, "Spectrum sensing for cognitive radio," *Proc. IEEE*, vol. 97, no. 5, pp. 849–877, May 2009.
- [30] Y. T. Hou, Y. Shi, and H. D. Sherali, "Spectrum sharing for multi-hop networking with cognitive radios," *IEEE J. Sel. Areas Commun.*, vol. 26, no. 1, pp. 146–155, Jan. 2008.
- [31] M. Höyhty *et al.*, "Spectrum occupancy measurements: A survey and use of interference maps," *IEEE Commun. Surveys Tuts.*, vol. 18, no. 4, pp. 2386–2414, 4th Quart., 2016.
- [32] L. Lai, H. E. Gamal, H. Jiang, and H. V. Poor, "Cognitive medium access: Exploration, exploitation, and competition," *IEEE Trans. Mobile Comput.*, vol. 10, no. 2, pp. 239–253, Feb. 2011.
- [33] W.-Y. Lee and I. F. Akyildiz, "Spectrum-aware mobility management in cognitive radio cellular networks," *IEEE Trans. Mobile Comput.*, vol. 11, no. 4, pp. 529–542, Apr. 2012.
- [34] W. Liang, S.-X. Ng, and L. Hanzo, "Cooperative overlay spectrum access for cognitive radio networks," *IEEE Commun. Surveys Tuts.*, to be published.
- [35] M. T. Masonta, M. Mzyece, and N. Ntlatlapa, "Spectrum decision in cognitive radio networks: A survey," *IEEE Commun. Surveys Tuts.*, vol. 15, no. 3, pp. 1088–1107, 3rd Quart., 2013.
- [36] D. Niyato and E. Hossain, "Competitive spectrum sharing in cognitive radio networks: A dynamic game approach," *IEEE Trans. Wireless Commun.*, vol. 7, no. 7, pp. 2651–2660, Jul. 2008.
- [37] S. Pandit and G. Singh, "An overview of spectrum sharing techniques in cognitive radio communication system," *Wireless Netw.*, vol. 23, no. 2, pp. 497–518, 2017.
- [38] F. Paisana, N. Marchetti, and L. A. DaSilva, "Radar, TV and cellular bands: Which spectrum access techniques for which bands?" *IEEE Commun. Surveys Tuts.*, vol. 16, no. 3, pp. 1193–1220, 3rd Quart., 2014.
- [39] S. K. Sharma, E. Lagunas, S. Chatzinotas, and B. Ottersten, "Application of compressive sensing in cognitive radio communications: A survey," *IEEE Commun. Surveys Tuts.*, vol. 18, no. 3, pp. 1838–1860, 3rd Quart., 2016.
- [40] Y. Saleem and M. H. Rehmani, "Primary radio user activity models for cognitive radio networks: A survey," *J. Netw. Comput. Appl.*, vol. 43, pp. 1–16, Aug. 2014.
- [41] E. Z. Tragos, S. Zeadally, A. G. Fragkiadakis, and V. A. Siris, "Spectrum assignment in cognitive radio networks: A comprehensive survey," *IEEE Commun. Surveys Tuts.*, vol. 15, no. 3, pp. 1108–1135, 3rd Quart., 2013.
- [42] M. van der Schaar and F. Fu, "Spectrum access games and strategic learning in cognitive radio networks for delay-critical applications," *Proc. IEEE*, vol. 97, no. 4, pp. 720–740, Apr. 2009.
- [43] T. Yucek and H. Arslan, "A survey of spectrum sensing algorithms for cognitive radio applications," *IEEE Commun. Surveys Tuts.*, vol. 11, no. 1, pp. 116–130, 1st Quart., 2009.
- [44] Y. Xu *et al.*, "Decision-theoretic distributed channel selection for opportunistic spectrum access: Strategies, challenges and solutions," *IEEE Commun. Surveys Tuts.*, vol. 15, no. 4, pp. 1689–1713, 4th Quart., 2013.
- [45] Y. Zeng and Y.-C. Liang, "Eigenvalue-based spectrum sensing algorithms for cognitive radio," *IEEE Trans. Commun.*, vol. 57, no. 6, pp. 1784–1793, Jun. 2009.
- [46] A. A. Khan, M. H. Rehmani, and M. Reisslein, "Requirements, design challenges, and review of routing and MAC protocols for CR-based smart grid systems," *IEEE Commun. Mag.*, vol. 55, no. 5, pp. 206–215, May 2017.
- [47] Y. Saleem, K.-L. A. Yau, H. Mohamad, N. Ramli, and M. H. Rehmani, "SMART: A spectrum-aware cluster-based routing scheme for distributed cognitive radio networks," *Comput. Netw.*, vol. 91, pp. 196–224, Nov. 2015.
- [48] M. Youssef, M. Ibrahim, M. Abdelatif, C. Lin, and A. V. Vasilakos, "Routing metrics of cognitive radio networks: A survey," *IEEE Commun. Surveys Tuts.*, vol. 16, no. 1, pp. 92–109, 1st Quart., 2014.
- [49] R. Tandra, S. M. Mishra, and A. Sahai, "What is a spectrum hole and what does it take to recognize one?" *Proc. IEEE*, vol. 97, no. 5, pp. 824–848, May 2009.
- [50] A. De Domenico, E. C. Strinati, and M.-G. Di Benedetto, "A survey on MAC strategies for cognitive radio networks," *IEEE Commun. Surveys Tuts.*, vol. 14, no. 1, pp. 21–44, 1st Quart., 2012.
- [51] L. Gavrilovska, D. Denkovski, V. Rakovic, and M. Angjelichinoski, "Medium access control protocols in cognitive radio networks: Overview and general classification," *IEEE Commun. Surveys Tuts.*, vol. 16, no. 4, pp. 2092–2124, 4th Quart., 2014.
- [52] G. Baldini *et al.*, "Security aspects in software defined radio and cognitive radio networks: A survey and a way ahead," *IEEE Commun. Surveys Tuts.*, vol. 14, no. 2, pp. 355–379, 2nd Quart., 2012.
- [53] J. Esch, "A survey of security challenges in cognitive radio networks: Solutions and future research directions," *Proc. IEEE*, vol. 100, no. 12, pp. 3170–3171, Dec. 2012.

- [54] A. G. Fragkiadakis, E. Z. Tragos, and I. G. Askoxylakis, "A survey on security threats and detection techniques in cognitive radio networks," *IEEE Commun. Surveys Tuts.*, vol. 15, no. 1, pp. 428–445, 1st Quart., 2013.
- [55] M. Grissa, B. Hamdaoui, and A. A. Yavuz, "Location privacy in cognitive radio networks: A survey," *IEEE Commun. Surveys Tuts.*, to be published.
- [56] H. Li and Z. Han, "Dogfight in spectrum: Combating primary user emulation attacks in cognitive radio systems—Part II: Unknown channel statistics," *IEEE Trans. Wireless Commun.*, vol. 10, no. 1, pp. 274–283, Jan. 2011.
- [57] R. K. Sharma and D. B. Rawat, "Advances on security threats and countermeasures for cognitive radio networks: A survey," *IEEE Commun. Surveys Tuts.*, vol. 17, no. 2, pp. 1023–1043, 2nd Quart., 2015.
- [58] L. Zhang *et al.*, "Byzantine attack and defense in cognitive radio networks: A survey," *IEEE Commun. Surveys Tuts.*, vol. 17, no. 3, pp. 1342–1363, 3rd Quart., 2015.
- [59] Y. Chen and H.-S. Oh, "A survey of measurement-based spectrum occupancy modeling for cognitive radios," *IEEE Commun. Surveys Tuts.*, vol. 18, no. 1, pp. 848–859, 1st Quart., 2016.
- [60] X. Huang, T. Han, and N. Ansari, "On green-energy-powered cognitive radio networks," *IEEE Commun. Surveys Tuts.*, vol. 17, no. 2, pp. 827–842, 2nd Quart., 2015.
- [61] M. E. Tanab and W. Hamouda, "Resource allocation for underlay cognitive radio networks: A survey," *IEEE Commun. Surveys Tuts.*, vol. 19, no. 2, pp. 1249–1276, 2nd Quart., 2017.
- [62] G. Gür and F. Alagoz, "Green wireless communications via cognitive dimension: An overview," *IEEE Netw.*, vol. 25, no. 2, pp. 50–56, Mar./Apr. 2011.
- [63] M. Bkassiny, L. Yang, and S. K. Jayaweera, "A survey on machine-learning techniques in cognitive radios," *IEEE Commun. Surveys Tuts.*, vol. 15, no. 3, pp. 1136–1159, 3rd Quart., 2013.
- [64] C. Clancy, J. Hecker, E. Stuntebeck, and T. O'Shea, "Applications of machine learning to cognitive radio networks," *IEEE Wireless Commun.*, vol. 14, no. 4, pp. 47–52, Aug. 2007.
- [65] A. He *et al.*, "A survey of artificial intelligence for cognitive radios," *IEEE Trans. Veh. Technol.*, vol. 59, no. 4, pp. 1578–1592, May 2010.
- [66] C. Cordeiro, K. Challapali, D. Birru, and S. Shankar, "IEEE 802.22: The first worldwide wireless standard based on cognitive radios," in *Proc. IEEE Int. Symp. New Front. Dyn. Spectr. Access Netw. (DySPAN)*, Baltimore, MD, USA, 2005, pp. 328–337.
- [67] F. Granelli *et al.*, "Standardization and research in cognitive and dynamic spectrum access networks: IEEE SCC41 efforts and other activities," *IEEE Commun. Mag.*, vol. 48, no. 1, pp. 71–79, Jan. 2010.
- [68] M. Murrioni *et al.*, "IEEE 1900.6: Spectrum sensing interfaces and data structures for dynamic spectrum access and other advanced radio communication systems standard: Technical aspects and future outlook," *IEEE Commun. Mag.*, vol. 49, no. 12, pp. 118–127, Dec. 2011.
- [69] T. N. Le, W.-L. Chin, and H.-H. Chen, "Standardization and security for smart grid communications based on cognitive radio technologies—A comprehensive survey," *IEEE Commun. Surveys Tuts.*, vol. 19, no. 1, pp. 423–445, 1st Quart., 2017.
- [70] C. R. Stevenson *et al.*, "IEEE 802.22: The first cognitive radio wireless regional area network standard," *IEEE Commun. Mag.*, vol. 47, no. 1, pp. 130–138, Jan. 2009.
- [71] H. Alves, R. D. Souza, and M. E. Pellenz, "Brief survey on full-duplex relaying and its applications on 5G," in *Proc. Int. Workshop Comput. Aided Model. Design Commun. Links Netw.*, Guildford, U.K., 2015, pp. 17–21.
- [72] Z. Zhang, K. Long, A. V. Vasilakos, and L. Hanzo, "Full-duplex wireless communications: Challenges, solutions, and future research directions," *Proc. IEEE*, vol. 104, no. 7, pp. 1369–1409, Jul. 2016.
- [73] Y. Liao, T. Wang, L. Song, and Z. Han, "Listen-and-talk: Protocol design and analysis for full-duplex cognitive radio networks," *IEEE Trans. Veh. Technol.*, vol. 66, no. 1, pp. 656–667, Jan. 2017.
- [74] Q. Zhao and B. M. Sadler, "A survey of dynamic spectrum access," *IEEE Signal Process. Mag.*, vol. 24, no. 3, pp. 79–89, May 2007.
- [75] A. Azarfard, J.-F. Frigon, and B. Sanso, "Improving the reliability of wireless networks using cognitive radios," *IEEE Commun. Surveys Tuts.*, vol. 14, no. 2, pp. 338–354, 2nd Quart., 2012.
- [76] J. Wang, M. Ghosh, and K. Challapali, "Emerging cognitive radio applications: A survey," *IEEE Commun. Mag.*, vol. 49, no. 3, pp. 74–81, Mar. 2011.
- [77] A. A. Khan, M. H. Rehmani, and M. Reisslein, "Cognitive radio for smart grids: Survey of architectures, spectrum sensing mechanisms, and networking protocols," *IEEE Commun. Surveys Tuts.*, vol. 18, no. 1, pp. 860–898, 1st Quart., 2016.
- [78] O. B. Akan, O. B. Karli, and O. Ergul, "Cognitive radio sensor networks," *IEEE Netw.*, vol. 23, no. 4, pp. 34–40, Jul./Aug. 2009.
- [79] Y. Saleem, M. H. Rehmani, and S. Zeadally, "Integration of cognitive radio technology with unmanned aerial vehicles: Issues, opportunities, and future research challenges," *J. Netw. Comput. Appl.*, vol. 50, pp. 15–31, Apr. 2015.
- [80] M. Jain *et al.*, "Practical, real-time, full duplex wireless," in *Proc. ACM Int. Conf. Mobile Comput. Netw. (MobiCom)*, Las Vegas, NV, USA, 2011, pp. 301–312.
- [81] C.-X. Wang *et al.*, "Cellular architecture and key technologies for 5G wireless communication networks," *IEEE Commun. Mag.*, vol. 52, no. 2, pp. 122–130, Feb. 2014.
- [82] B. Kim *et al.*, "Non-orthogonal multiple access in a downlink multiuser beamforming system," in *Proc. IEEE Mil. Commun. Conf.*, San Diego, CA, USA, 2013, pp. 1278–1283.
- [83] J. Choi, "Non-orthogonal multiple access in downlink coordinated two-point systems," *IEEE Commun. Lett.*, vol. 18, no. 2, pp. 313–316, Feb. 2014.
- [84] G. Wunder *et al.*, "5GNOW: Challenging the LTE design paradigms of orthogonality and synchronicity," in *Proc. IEEE Veh. Technol. Conf. (VTC Spring)*, Dresden, Germany, 2013, pp. 1–5.
- [85] A. Goldsmith, *Wireless Communications*. New York, NY, USA: Cambridge Univ. Press, 2005.
- [86] D. Bharadia, E. McMilin, and S. Katti, "Full duplex radios," *ACM SIGCOMM Comput. Commun. Rev.*, vol. 43, no. 4, pp. 375–386, 2013.
- [87] A. Sabharwal *et al.*, "In-band full-duplex wireless: Challenges and opportunities," *IEEE J. Sel. Areas Commun.*, vol. 32, no. 9, pp. 1637–1652, Sep. 2014.
- [88] X.-T. Doan, N.-P. Nguyen, C. Yin, D. B. da Costa, and T. Q. Duong, "Cognitive full-duplex relay networks under the peak interference power constraint of multiple primary users," *EURASIP J. Wireless Commun. Netw.*, vol. 2017, no. 1, pp. 1–10, 2017.
- [89] C. Yin, T. X. Doan, N.-P. Nguyen, T. Mai, and L. D. Nguyen, "Outage probability of full-duplex cognitive relay networks with partial relay selection," in *Proc. IEEE Int. Conf. Recent Adv. Signal Process. Telecommun. Comput. (SigTelCom)*, Jan. 2017, pp. 115–118.
- [90] M. Deng, B. J. Hu, and X. Li, "Adaptive weighted sensing with simultaneous transmission for dynamic primary user traffic," *IEEE Trans. Commun.*, vol. 65, no. 3, pp. 992–1004, Mar. 2017.
- [91] J. Jia, Q. Zhang, and X. S. Shen, "HC-MAC: A hardware-constrained cognitive MAC for efficient spectrum management," *IEEE J. Sel. Areas Commun.*, vol. 26, no. 1, pp. 106–117, Jan. 2008.
- [92] Q. Zhao, L. Tong, A. Swami, and Y. Chen, "Decentralized cognitive MAC for opportunistic spectrum access in ad hoc networks: A POMDP framework," *IEEE J. Sel. Areas Commun.*, vol. 25, no. 3, pp. 589–600, Apr. 2007.
- [93] M.-L. Ku, W. Li, Y. Chen, and K. J. R. Liu, "Advances in energy harvesting communications: Past, present, and future challenges," *IEEE Commun. Surveys Tuts.*, vol. 18, no. 2, pp. 1384–1412, 2nd Quart., 2016.
- [94] L. Liu, Y. Zhang, S. Liu, and Z. Zhang, "Power allocation optimization for D2D communication underlying cognitive full duplex relay networks," in *Proc. Int. Conf. Wireless Commun. Netw. Mobile Comput. (WiCOM)*, Shanghai, China, 2015, pp. 1–6.
- [95] N. Li, Y. Li, T. Wang, M. Peng, and W. Wang, "Full-duplex based spectrum sharing in cognitive two-way relay networks," in *Proc. IEEE Int. Symp. Pers. Indoor Mobile Radio Commun. (PIMRC)*, Hong Kong, 2015, pp. 997–1001.
- [96] V. Syrjala and M. Valkama, "Coexistence of LTE and WLAN in unlicensed bands: Full-duplex spectrum sensing," in *Proc. Int. Conf. Cogn. Radio Orient. Wireless Netw.*, vol. 156, Doha, Qatar, 2015, pp. 725–734.
- [97] T. Wang, Y. Liao, B. Zhang, and L. Song, "Joint spectrum access and power allocation in full-duplex cognitive cellular networks," in *Proc. IEEE ICC Mobile Wireless Netw. Symp.*, London, U.K., 2015, pp. 3329–3334.
- [98] E. E. B. Olivo, D. P. M. Osorio, H. Alves, J. C. S. Filho, and M. Latva-Aho, "An adaptive transmission scheme for cognitive decode-and-forward relaying networks: Half duplex, full duplex, or no cooperation," *IEEE Trans. Wireless Commun.*, vol. 15, no. 8, pp. 5586–5602, Aug. 2016.
- [99] E. Ahmed, A. Eltawil, and A. Sabharwal, "Simultaneous transmit and sense for cognitive radios using full-duplex: A first study," in *Proc. Antennas Propag. Soc. Int. Symp.*, Chicago, IL, USA, 2012, pp. 1–2.
- [100] Y. Liao, T. Wang, L. Song, and Z. Han, "Listen-and-talk: Full-duplex cognitive radio networks," in *Proc. IEEE Glob. Commun. Conf.*, Austin, TX, USA, 2014, pp. 3068–3073.

- [101] T. Riihonen and R. Wichman, "Energy detection in full-duplex cognitive radios under residual self-interference," in *Proc. Int. Conf. Cogn. Radio Orient. Wireless Netw. Commun.*, Oulu, Finland, 2014, pp. 57–60.
- [102] A. F. Molisch, L. J. Greenstein, and M. Shafi, "Propagation issues for cognitive radio," *Proc. IEEE*, vol. 97, no. 5, pp. 787–804, May 2009.
- [103] M. P. Chang and P. R. Prucnal, "A photonic integrated circuit for full duplex spectrum monitoring in cognitive radio," in *Proc. IEEE Summer Topicals Meeting*, Nassau, The Bahamas, 2015, p. 105.
- [104] Y. Liao, T. Wang, L. Song, and B. Jiao, "Cooperative spectrum sensing for full-duplex cognitive radio networks," in *Proc. Int. Conf. Commun. Syst.*, 2014, pp. 56–60.
- [105] L. T. Tan and L. B. Le, "Distributed MAC protocol design for full-duplex cognitive radio networks," in *Proc. IEEE Glob. Commun. Conf. (GLOBECOM)*, San Diego, CA, USA, Dec. 2015, pp. 1–6.
- [106] G. J. González, F. H. Gregorio, J. E. Cousseau, T. Riihonen, and R. Wichman, "Full-duplex amplify-and-forward relays with optimized transmission power under imperfect transceiver electronics," *EURASIP J. Wireless Commun. Netw.*, vol. 2017, no. 76, pp. 1–12, Apr. 2017.
- [107] S. K. Sharma *et al.*, "Cognitive radio techniques under practical imperfections: A survey," *IEEE Commun. Surveys Tuts.*, vol. 17, no. 4, pp. 1858–1884, 4th Quart., 2015.
- [108] A.-A. A. Boulogeorgos, H. A. B. Salameh, and G. K. Karagiannidis, "Spectrum sensing in full-duplex cognitive radio networks under hardware imperfections," *IEEE Trans. Veh. Technol.*, vol. 66, no. 3, pp. 2072–2084, Mar. 2017.
- [109] C. N. Devanarayana and A. S. Alfa, "Decentralized channel assignment and power allocation in a full-duplex cognitive radio network," in *Proc. IEEE Annu. Consum. Commun. Netw. Conf. (CCNC)*, Las Vegas, NV, USA, 2016, pp. 829–832.
- [110] T. Yang, R. Zhang, X. Cheng, and L. Yang, "Graph coloring based resource sharing (GCRS) scheme for D2D communications underlaying full-duplex cellular networks," *IEEE Trans. Veh. Technol.*, to be published.
- [111] W. Afifi and M. Krunz, "Incorporating self-interference suppression for full-duplex operation in opportunistic spectrum access systems," *IEEE Trans. Wireless Commun.*, vol. 14, no. 4, pp. 2180–2191, Apr. 2015.
- [112] N. Tang, S. Mao, and S. Kompella, "Power control in full duplex underlay cognitive radio networks: A control theoretic approach," in *Proc. IEEE Mil. Commun. Conf.*, Baltimore, MD, USA, 2014, pp. 949–954.
- [113] N. Tang, S. Mao, and S. Kompella, "On power control in full duplex underlay cognitive radio networks," *Ad Hoc Netw.*, vol. 37, no. 2, pp. 183–194, 2015.
- [114] T. M. C. Chu and H.-J. Zepernick, "On capacity of full-duplex cognitive cooperative radio networks with optimal power allocation," in *Proc. IEEE Wireless Commun. Netw. Conf. (WCNC)*, San Francisco, CA, USA, Mar. 2017, pp. 1–6.
- [115] L. T. Tan, L. Ying, and D. W. Bliss, "Power control and relay selection in full-duplex cognitive relay networks: Coherent versus non-coherent scenarios," in *Proc. IEEE Annu. Conf. Inf. Sci. Syst. (CISS)*, Baltimore, MD, USA, Mar. 2017, pp. 1–6.
- [116] D. Xu and Q. Li, "Resource allocation in underlay cognitive radio networks with full-duplex cognitive base station," *Int. J. Commun. Syst.*, to be published.
- [117] L. Zhang, M. Xiao, G. Wu, G. Zhao, and S. Li, "Proactive cross-channel gain estimation for spectrum sharing in cognitive radio networks," in *Proc. IEEE Wireless Commun. Netw. Conf. (WCNC)*, San Francisco, CA, USA, 2017, pp. 1–5.
- [118] S. B. Mafra *et al.*, "On the performance of cognitive full-duplex relaying under spectrum sharing constraints," *EURASIP J. Wireless Commun. Netw.*, vol. 2015, no. 1, pp. 1–13, 2015.
- [119] M. G. Khafagy, M.-S. Alouini, and S. Aissa, "Full-duplex opportunistic relay selection in future spectrum-sharing networks," in *Proc. Int. Conf. Commun. Workshop*, London, U.K., 2015, pp. 1196–1200.
- [120] Y. Deng *et al.*, "Full-duplex spectrum sharing in cooperative single carrier systems," in *Proc. IEEE Wireless Commun. Netw. Conf.*, New Orleans, LA, USA, 2015, pp. 25–30.
- [121] G. Zhao, B. Huang, L. Li, and Z. Chen, "Estimate the primary-link SNR using full-duplex relay for underlay spectrum sharing," *IEEE Signal Process. Lett.*, vol. 23, no. 4, pp. 429–433, Apr. 2016.
- [122] B. Radunovic *et al.*, "Rethinking indoor wireless mesh design: Low power, low frequency, full-duplex," in *Proc. IEEE Int. Workshop Wireless Mesh Netw. (WIMESH)*, Boston, MA, USA, 2010, pp. 1–6.
- [123] A. C. Cirik, R. Wang, Y. Rong, and Y. Hua, "MSE-based transceiver designs for full-duplex MIMO cognitive radios," *IEEE Trans. Commun.*, vol. 63, no. 6, pp. 2056–2070, Jun. 2015.
- [124] G. Zheng, I. Krikidis, and B. O. Ottersten, "Full-duplex cooperative cognitive radio with transmit imperfections," *IEEE Trans. Wireless Commun.*, vol. 12, no. 5, pp. 2498–2511, May 2015.
- [125] O. Simeone, E. Erkip, and S. Shamai, "Full-duplex cloud radio access networks: An information-theoretic viewpoint," *IEEE Wireless Commun. Lett.*, vol. 3, no. 4, pp. 413–416, Aug. 2014.
- [126] J. I. Choi, M. Jain, K. Srinivasan, P. Levis, and S. Katti, "Achieving single channel, full duplex wireless communication," in *Proc. ACM Int. Conf. Mobile Comput. Netw. (MobiCom)*, Chicago, IL, USA, 2010, pp. 1–12.
- [127] H. Ju and R. Zhang, "Optimal resource allocation in full-duplex wireless-powered communication network," *IEEE Trans. Commun.*, vol. 62, no. 10, pp. 3528–3540, Oct. 2014.
- [128] M. Gaafar, O. Amin, W. Abediseid, and M.-S. Alouini, "Underlay spectrum sharing techniques with in-band full-duplex systems using improper Gaussian signaling," *IEEE Trans. Wireless Commun.*, vol. 16, no. 1, pp. 235–249, Jan. 2017.
- [129] O. Amin, W. Abediseid, and M.-S. Alouini, "Overlay spectrum sharing using improper Gaussian signaling," *IEEE J. Sel. Areas Commun.*, vol. 35, no. 1, pp. 50–62, Jan. 2017.
- [130] J. Zou, H. Xiong, D. Wang, and C. W. Chen, "Optimal power allocation for hybrid overlay/underlay spectrum sharing in multiband cognitive radio networks," *IEEE Trans. Veh. Technol.*, vol. 62, no. 4, pp. 1827–1837, May 2013.
- [131] J. Yee and H. Pezeshki-Esfahani, "Understanding wireless LAN performance trade-offs," *Commun. Syst. Design*, vol. 11, pp. 32–35, Nov. 2002.
- [132] T. Huang, B. Ye, S. Guo, T. Miyazaki, and S. Lu, "Delay minimization by exploring full-duplex capacity and relay-based cooperative scheduling in WLANs," *J. Netw. Comput. Appl.*, vol. 46, pp. 407–417, Nov. 2014.
- [133] M. Duarte and A. Sabharwal, "Full-duplex wireless communications using off-the-shelf radios: Feasibility and first results," in *Proc. Asilomar Conf. Signals Syst. Comput.*, Pacific Grove, CA, USA, 2010, pp. 1558–1562.
- [134] A. Sahai, G. Patel, and A. Sabharwal, "Pushing the limits of full-duplex: Design and real-time implementation," *arXiv preprint arXiv:1107.0607*, 2011.
- [135] A. K. Khandani, "Two-way (true full-duplex) wireless," in *Proc. Can. Workshop Inf. Theory (CWIT)*, Toronto, ON, Canada, 2013, pp. 33–38.
- [136] M. Duarte *et al.*, "Design and characterization of a full-duplex multi-antenna system for WiFi networks," *IEEE Trans. Veh. Technol.*, vol. 63, no. 3, pp. 1160–1177, Mar. 2012.
- [137] E. Everett, A. Sahai, and A. Sabharwal, "Passive self-interference suppression for full-duplex infrastructure nodes," *IEEE Trans. Wireless Commun.*, vol. 13, no. 2, pp. 680–694, Feb. 2014.
- [138] E. Everett, M. Duarte, C. Dick, and A. Sabharwal, "Empowering full-duplex wireless communication by exploiting directional diversity," in *Proc. Asilomar Conf. Signals Syst. Comput.*, Pacific Grove, CA, USA, 2011, pp. 2002–2006.
- [139] M. Duarte, C. Dick, and A. Sabharwal, "Experiment-driven characterization of full-duplex wireless systems," *IEEE Trans. Wireless Commun.*, vol. 11, no. 12, pp. 4296–4307, Dec. 2012.
- [140] D. Korpi *et al.*, "Advanced self-interference cancellation and multi-antenna techniques for full-duplex radios," in *Proc. Asilomar Conf. Signals Syst. Comput.*, Pacific Grove, CA, USA, 2013, pp. 3–8.
- [141] M. Kamel, W. Hamouda, and A. Youssef, "Ultra-dense networks: A survey," *IEEE Commun. Surveys Tuts.*, vol. 18, no. 4, pp. 2522–2545, 4th Quart., 2016.
- [142] D. López-Pérez, M. Ding, H. Claussen, and A. H. Jafari, "Towards 1 Gbps/UE in cellular systems: Understanding ultra-dense small cell deployments," *IEEE Commun. Surveys Tuts.*, vol. 17, no. 4, pp. 2078–2101, 4th Quart., 2015.
- [143] A. S. Thyagaturu, Y. Dashti, and M. Reisslein, "SDN-based smart gateways (Sm-GWs) for multi-operator small cell network management," *IEEE Trans. Netw. Service Manag.*, vol. 13, no. 4, pp. 740–753, Dec. 2016.
- [144] S. Goyal *et al.*, "Full duplex operation for small cells," *arXiv preprint arXiv:1412.8708*, 2014.
- [145] D. Nguyen, L.-N. Tran, P. Pirinen, and M. Latva-Aho, "Transmission strategies for full duplex multiuser MIMO systems," in *Proc. IEEE Int. Conf. Commun. (ICC)*, Ottawa, ON, Canada, 2012, pp. 6825–6829.
- [146] D. Nguyen, L.-N. Tran, P. Pirinen, and M. Latva-Aho, "On the spectral efficiency of full-duplex small cell wireless systems," *IEEE Trans. Wireless Commun.*, vol. 13, no. 9, pp. 4896–4910, Sep. 2014.

- [147] J.-H. Lee and O.-S. Shin, "Full-duplex relay based on zero-forcing beamforming," *IEICE Trans. Commun.*, vol. 94, no. 4, pp. 978–985, 2011.
- [148] E. Everett and A. Sabharwal, "Spatial self-interference isolation for in-band full-duplex wireless: A degrees-of-freedom analysis," *arXiv preprint arXiv:1506.03394*, 2015.
- [149] B. P. Day, A. R. Margetts, D. W. Bliss, and P. Schniter, "Full-duplex bidirectional MIMO: Achievable rates under limited dynamic range," *IEEE Trans. Signal Process.*, vol. 60, no. 7, pp. 3702–3713, Jul. 2012.
- [150] E. Antonio-Rodríguez, R. López-Valcarce, T. Riihonen, S. Werner, and R. Wichman, "Adaptive self-interference cancellation in wideband full-duplex decode-and-forward MIMO relays," in *Proc. IEEE Workshop Signal Process. Adv. Wireless Commun. (SPAWC)*, Darmstadt, Germany, 2013, pp. 370–374.
- [151] E. Aryafar, M. A. Khojastepour, K. Sundaresan, S. Rangarajan, and M. Chiang, "MIDU: Enabling MIMO full duplex," in *Proc. ACM Int. Conf. Mobile Comput. Netw. (MobiCom)*, Istanbul, Turkey, 2012, pp. 257–268.
- [152] B. P. Day, A. R. Margetts, D. W. Bliss, and P. Schniter, "Full-duplex MIMO relaying: Achievable rates under limited dynamic range," *IEEE J. Sel. Areas Commun.*, vol. 30, no. 8, pp. 1541–1553, Sep. 2012.
- [153] Y. Hua, P. Liang, Y. Ma, A. C. Cirik, and Q. Gao, "A method for broadband full-duplex MIMO radio," *IEEE Signal Process. Lett.*, vol. 19, no. 12, pp. 793–796, Dec. 2012.
- [154] S. Huberman and T. Le-Ngoc, "Self-interference pricing for full-duplex MIMO systems," in *Proc. IEEE Glob. Commun. Conf.*, Atlanta, GA, USA, 2013, pp. 3902–3906.
- [155] D. Nguyen, L.-N. Tran, P. Pirinen, and M. Latva-Aho, "Precoding for full duplex multiuser MIMO systems: Spectral and energy efficiency maximization," *IEEE Trans. Signal Process.*, vol. 61, no. 16, pp. 4038–4050, Aug. 2013.
- [156] T. Riihonen, S. Werner, and R. Wichman, "Residual self-interference in full-duplex MIMO relays after null-space projection and cancellation," in *Proc. Conf. Rec. 44th Asilomar Conf. Signals Syst. Comput.*, Pacific Grove, CA, USA, 2010, pp. 653–657.
- [157] Y. Shi, L. Zhang, Z. Chen, Y. Gong, and G. Wu, "Optimal power allocation for AF full-duplex relay in cognitive radio networks," in *Proc. Globecom Workshops*, Atlanta, GA, USA, 2013, pp. 322–327.
- [158] W. Cheng, X. Zhang, and H. Zhang, "Full duplex wireless communications for cognitive radio networks," *arXiv preprint arXiv:1105.0034*, 2011.
- [159] W. Afifi and M. Krunz, "Exploiting self-interference suppression for improved spectrum awareness/efficiency in cognitive radio systems," in *Proc. IEEE INFOCOM*, Turin, Italy, 2013, pp. 1258–1266.
- [160] S. ElAzzouni, O. Ercetin, A. El-Keyi, T. ElBatt, and M. Nafie, "Full-duplex cooperative cognitive radio networks," in *Proc. IEEE Int. Symp. Model. Optim. Mobile Ad Hoc Wireless Netw. (WiOpt)*, Mumbai, India, 2015, pp. 475–482.
- [161] P. D. L. Beasley, A. G. Stove, B. J. Reits, and B. As, "Solving the problems of a single antenna frequency modulated CW radar," in *Proc. Radar Conf.*, Arlington, VA, USA, 1990, pp. 391–395.
- [162] M. Zhou, H. Cui, L. Song, and B. Jiao, "Transmit-receive antenna pair selection in full duplex systems," *IEEE Wireless Commun. Lett.*, vol. 3, no. 1, pp. 34–37, Feb. 2014.
- [163] C. Zhong, H. A. Suraweera, G. Zheng, I. Krikidis, and Z. Zhang, "Wireless information and power transfer with full duplex relaying," *IEEE Trans. Commun.*, vol. 62, no. 10, pp. 3447–3461, Oct. 2014.
- [164] C. Yao, K. Yang, L. Song, and Y. Li, "X-Duplex: Adapting of full-duplex and half-duplex," in *Proc. Int. Conf. Comput. Commun. Workshop*, Hong Kong, 2015, pp. 55–56.
- [165] I. F. Akyildiz, W.-Y. Lee, and K. R. Chowdhury, "CRAHNs: Cognitive radio ad hoc networks," *Ad Hoc Netw.*, vol. 7, no. 5, pp. 810–836, 2009.
- [166] A. C. Cirik, S. Biswas, O. Taghizadeh, A. Liu, and T. Ratnarajah, "Robust transceiver design in full-duplex MIMO cognitive radios," in *Proc. IEEE Int. Conf. Commun. (ICC)*, Kuala Lumpur, Malaysia, 2016, pp. 1–7.
- [167] A. C. Cirik, M. C. Filippou, and T. Ratnarajah, "Transceiver design in full-duplex MIMO cognitive radios under channel uncertainties," *IEEE Trans. Cogn. Commun. Netw.*, vol. 2, no. 1, pp. 1–14, Mar. 2016.
- [168] H. ElSawy, E. Hossain, and M. Haenggi, "Stochastic geometry for modeling, analysis, and design of multi-tier and cognitive cellular wireless networks: A survey," *IEEE Commun. Surveys Tuts.*, vol. 15, no. 3, pp. 996–1019, 3rd Quart., 2013.
- [169] X. Zhang, W. Cheng, and H. Zhang, "Full-duplex transmission in PHY and MAC layers for 5G mobile wireless networks," *IEEE Wireless Commun.*, vol. 22, no. 5, pp. 112–121, Oct. 2015.
- [170] L. Song, Y. Liao, and L. Song, "Flexible full-duplex cognitive radio networks by antenna reconfiguration," in *Proc. IEEE/CIC Int. Conf. Commun. China (ICCC)*, Shenzhen, China, 2015, pp. 1–5.
- [171] B. Zhong *et al.*, "Performance analysis for opportunistic full-duplex relay selection in underlay cognitive networks," *IEEE Trans. Veh. Technol.*, vol. 64, no. 10, pp. 4905–4910, Oct. 2015.
- [172] S. Rajkumar and S. J. Thiruvengadam, "Performance analysis of OFDM based full duplex cognitive AF relay network in the presence of narrowband interference," in *Proc. IEEE Int. Conf. Signal Process. Informat. Commun. Energy Syst. (SPICES)*, Kozhikode, India, 2015, pp. 1–5.
- [173] W. Afifi and M. Krunz, "TSRA: An adaptive mechanism for switching between communication modes in full-duplex opportunistic spectrum access systems," *IEEE Trans. Mobile Comput.*, vol. 16, no. 6, pp. 1758–1772, Jun. 2017.
- [174] D. Korpi *et al.*, "Full-duplex mobile device—Pushing the limits," *IEEE Commun. Mag.*, vol. 54, no. 9, pp. 80–87, Sep. 2016.
- [175] Z. Zhang, X. Chai, K. Long, A. V. Vasilakos, and L. Hanzo, "Full duplex techniques for 5G networks: Self-interference cancellation, protocol design, and relay selection," *IEEE Commun. Mag.*, vol. 53, no. 5, pp. 128–137, May 2015.
- [176] H. Li, H. Lv, and H. Yuan, "Resource allocation for full duplex based cognitive radio network," in *Proc. Int. Conf. Comput. Sci. Netw. Technol.*, Changchun, China, 2012, pp. 1116–1120.
- [177] M. P. Chang, P. R. Prucnal, and Y. Deng, "Full-duplex spectrum sensing in cognitive radios using optical self-interference cancellation," in *Proc. 9th Int. Conf. Sens. Technol. (ICST)*, Auckland, New Zealand, 2015, pp. 341–344.
- [178] M. A. Khojastepour, K. Sundaresan, S. Rangarajan, X. Zhang, and S. Barghi, "The case for antenna cancellation for scalable full-duplex wireless communications," in *Proc. 10th ACM Workshop Hot Topics Netw.*, Cambridge, MA, USA, 2011, pp. 1–6.
- [179] S. Goyal *et al.*, "Full duplex cellular systems: Will doubling interference prevent doubling capacity?" *IEEE Commun. Mag.*, vol. 53, no. 5, pp. 121–127, May 2015.
- [180] M. Biguesh and A. B. Gershman, "Training-based MIMO channel estimation: A study of estimator tradeoffs and optimal training signals," *IEEE Trans. Signal Process.*, vol. 54, no. 3, pp. 884–893, Mar. 2006.
- [181] Y. Liao, K. Bian, L. Ma, and L. Song, "Robust cooperative spectrum sensing in full-duplex cognitive radio networks," in *Proc. Int. Conf. Ubiquitous Future Netw.*, Sapporo, Japan, 2015, pp. 66–68.
- [182] W. Cheng, X. Zhang, and H. Zhang, "Full duplex spectrum sensing in non-time-slotted cognitive radio networks," in *Proc. IEEE Mil. Commun. Conf.*, Baltimore, MD, USA, 2011, pp. 1029–1034.
- [183] Y. Lu, D. Wang, and M. Fattouche, "Novel spectrum sensing scheme in cognitive radio by simultaneously sensing/transmitting at full-duplex Tx and BER measurements at Rx," in *Proc. IEEE Int. Symp. Pers. Indoor Mobile Radio Commun.*, Washington, DC, USA, 2014, pp. 638–642.
- [184] A. E. Shafie and T. Khattab, "Energy-efficient cooperative relaying protocol for full-duplex cognitive radio users and delay-aware primary users," in *Proc. IEEE Int. Conf. Comput. Netw. Commun.*, Garden Grove, CA, USA, 2015, pp. 207–213.
- [185] W. Cheng, S. X. Zhang, and H. Zhang, "Full-duplex spectrum-sensing and MAC-protocol for multichannel nontime-slotted cognitive radio networks," *IEEE J. Sel. Areas Commun.*, vol. 33, no. 5, pp. 820–831, May 2015.
- [186] E. Askari and S. Aïssa, "Full-duplex cognitive radio with packet fragmentation," in *Proc. IEEE Wireless Commun. Netw. Conf.*, Istanbul, Turkey, 2014, pp. 1502–1507.
- [187] W. Afifi and M. Krunz, "Adaptive transmission-reception-sensing strategy for cognitive radios with full-duplex capabilities," in *Proc. IEEE Int. Symp. Dyn. Spectr. Access Netw. (DYSpan)*, McLean, VA, USA, 2014, pp. 149–160.
- [188] R. Zhang and Y.-C. Liang, "Exploiting multi-antennas for opportunistic spectrum sharing in cognitive radio networks," *IEEE J. Sel. Areas Commun.*, vol. 2, no. 1, pp. 88–102, Feb. 2008.
- [189] V. Syrjala, M. Valkama, M. Allén, and K. Yamamoto, "Simultaneous transmission and spectrum sensing in OFDM systems using full-duplex radios," in *Proc. IEEE Veh. Technol. Conf. (VTC Fall)*, Boston, MA, USA, 2015, pp. 1–6.
- [190] R. Umar, A. U. H. Sheikh, and M. Deriche, "Unveiling the hidden assumptions of energy detector based spectrum sensing for cognitive radios," *IEEE Commun. Surveys Tuts.*, vol. 16, no. 2, pp. 713–728, 2nd Quart., 2014.

- [191] G. Caso, M. T. P. Le, L. De Nardis, and M.-G. Di Benedetto, "Non-cooperative and cooperative spectrum sensing in 5G cognitive networks," in *Handbook of Cognitive Radio*, W. Zhang, Ed. Singapore: Springer, 2017, pp. 1–21.
- [192] R. Zhu, Y. Li, F. Gao, J. Wang, and X. Xu, "Relay opportunistic spectrum sharing based on the full-duplex transceiver," *IEEE Trans. Veh. Technol.*, vol. 64, no. 12, pp. 5789–5803, Dec. 2015.
- [193] S. Ha, W. Lee, J. Kang, and J. Kang, "Cooperative spectrum sensing in non-time-slotted full duplex cognitive radio networks," in *Proc. IEEE Consum. Commun. Netw. Conf. (CCNC)*, Las Vegas, NV, USA, 2016, pp. 820–823.
- [194] P. V. Tuan and I. Koo, "Throughput maximisation by optimising detection thresholds in full-duplex cognitive radio networks," *IET Commun.*, vol. 10, no. 11, pp. 1355–1364, Jul. 2016.
- [195] O. Afisiadis, A. C. M. Austin, A. K. Balatsoukas-Stimming, and A. Burg, "Sliding window spectrum sensing for full-duplex cognitive radios with low access-latency," in *Proc. IEEE 83rd Veh. Technol. Conf.*, Nanjing, China, 2016, pp. 1–5.
- [196] L. T. Tan and L. B. Le, "Design and optimal configuration of full-duplex MAC protocol for cognitive radio networks considering self-interference," *IEEE Access*, vol. 3, pp. 2715–2729, 2015.
- [197] L. T. Tan and L. B. Le, "Multi-channel MAC protocol for full-duplex cognitive radio networks with optimized access control and load balancing," in *Proc. IEEE Int. Conf. Commun. (ICC)*, Kuala Lumpur, Malaysia, 2016, pp. 1–6.
- [198] Y. Liao, K. Bian, L. Song, and Z. Han, "Full-duplex MAC protocol design and analysis," *IEEE Commun. Lett.*, vol. 19, no. 7, pp. 1185–1188, Jul. 2015.
- [199] N. Choi, M. Patel, and S. Venkatesan, "A full duplex multi-channel MAC protocol for multi-hop cognitive radio networks," in *Proc. IEEE Int. Conf. Cogn. Radio Orient. Wireless Netw. Commun.*, 2006, pp. 1–5.
- [200] J. Zhang, G. Pan, and H.-M. Wang, "On physical-layer security in underlay cognitive radio networks with full-duplex wireless-powered secondary system," *IEEE Access*, vol. 4, pp. 3887–3893, 2016.
- [201] G. Chen, Y. Gong, P. Xiao, and J. A. Chambers, "Physical layer network security in the full-duplex relay system," *IEEE Trans. Inf. Forensics Secur.*, vol. 10, no. 3, pp. 574–583, Mar. 2015.
- [202] F. Zhu, F. Gao, T. Zhang, K. Sun, and M. Yao, "Physical-layer security for full duplex communications with self-interference mitigation," *IEEE Trans. Wireless Commun.*, vol. 15, no. 1, pp. 329–340, Jan. 2016.
- [203] G. Chen, Y. Gong, P. Xiao, and J. A. Chambers, "Dual antenna selection in secure cognitive radio networks," *IEEE Trans. Veh. Technol.*, vol. 65, no. 10, pp. 7993–8002, Oct. 2016.
- [204] F. Zheng, Y. Qian, and H. Li, "On the performance of full duplex cognitive anti-jamming receiver impaired by phase noise," in *Proc. IEEE Int. Conf. Signal Process. Commun. Comput. (ICSPCC)*, Ningbo, China, 2015, pp. 1–5.
- [205] T. Zhang *et al.*, "Secure multiantenna cognitive wiretap networks," *IEEE Trans. Veh. Technol.*, vol. 66, no. 5, pp. 4059–4072, May 2017.
- [206] T. Zhang, Y. Cai, Y. Huang, T. Q. Duong, and W. Yang, "Secure full-duplex spectrum-sharing wiretap networks with different antenna reception schemes," *IEEE Trans. Commun.*, vol. 65, no. 1, pp. 335–346, Jan. 2017.
- [207] N.-P. Nguyen, C. Kundu, H. Q. Ngo, T. Q. Duong, and B. Canberk, "Secure full-duplex small-cell networks in a spectrum sharing environment," *IEEE Access*, vol. 4, pp. 3087–3099, 2016.
- [208] Q. Xu, P. Ren, Q. Du, and L. Sun, "Secure secondary communications with curious primary users in cognitive underlay networks," in *Proc. IEEE Veh. Technol. Conf. (VTC Spring)*, Nanjing, China, 2016, pp. 1–5.
- [209] J.-H. Lee, "Full-duplex relay for enhancing physical layer security in multi-hop relaying systems," *IEEE Commun. Lett.*, vol. 19, no. 4, pp. 525–528, Apr. 2015.
- [210] I. K. Ahmed and A. O. Fapojuwo, "Security threat assessment of simultaneous multiple denial-of-service attacks in IEEE 802.22 cognitive radio networks," in *Proc. IEEE Int. Symp. World Wireless Mobile Multimedia Netw. (WoWMoM)*, Coimbra, Portugal, 2016, pp. 1–9.
- [211] T. Peng, Y. Chen, J. Xiao, Y. Zheng, and J. Yang, "Improved soft fusion-based cooperative spectrum sensing defense against SSSF attacks," in *Proc. Int. Conf. Comput. Inf. Telecommun. Syst. (CITS)*, Kunming, China, 2016, pp. 1–5.
- [212] R. Schneiderman, *TV White Space Standards Open New Markets*. Hoboken, NJ, USA: Wiley, 2015.
- [213] S. Filin, T. Baykas, H. Harada, F. Kojima, and H. Yano, "IEEE standard 802.19.1 for TV white space coexistence," *IEEE Commun. Mag.*, vol. 54, no. 3, pp. 22–26, Mar. 2016.
- [214] S. Filin, K. Ishizu, F. Kojima, and H. Harada, "Implementation of TV white space coexistence system based on IEEE 802.19.1 standard," in *Proc. IEEE Conf. Stand. Commun. Netw. (CSCN)*, Tokyo, Japan, 2015, pp. 206–211.
- [215] *IEEE Standards for Local and Metropolitan Area Networks: Supplements to Carrier Sense Multiple Access With Collision Detection (CSMA/CD) Access Method and Physical Layer Specifications—Specification for 802.3 Full Duplex Operation and Physical Layer Specification for 100 Mb/s Operation on Two Pairs of Category 3 or Better Balanced Twisted Pair Cable (100BASE-T2)*, IEEE Standard 802.3x-1997, 1997.
- [216] D. Kreiser and O. Sonom, "Collision-free full-duplex UWB communication based on the standard IEEE.802.15.4a," in *Proc. IEEE Wireless Commun. Netw. Conf. Workshops (WCNCW)*, New Orleans, LA, USA, 2015, pp. 81–84.
- [217] P. G. S. Velmurugan, M. Nandhini, and S. J. Thiruvengadam, "Full duplex relay based cognitive radio system with physical layer network coding," *Wireless Pers. Commun.*, vol. 80, no. 3, pp. 1113–1130, 2015.
- [218] H. Chen, S. Tan, and F. Zhao, "Outage performance of relay-assisted transmissions in cognitive full-duplex relay networks," *EURASIP J. Wireless Commun. Netw.*, vol. 2015, no. 1, pp. 1–11, 2015.
- [219] M. Hammouda, R. Zheng, and T. N. Davidson, "Full-duplex spectrum sensing and access in cognitive radio networks with unknown primary user activities," in *Proc. IEEE ICC*, Kuala Lumpur, Malaysia, 2016, pp. 1–6.
- [220] H. Kim, S. Lim, H. Wang, and D. Hong, "Power allocation and outage probability analysis for secondary users in cognitive full duplex relay systems," in *Proc. Int. Workshop Signal Process. Adv. Wireless Commun.*, Çeşme, Turkey, 2012, pp. 449–453.
- [221] B. Huang, G. Zhao, L. Li, X. Zhou, and Z. Chen, "Non-cooperative cross-channel gain estimation using full-duplex amplify-and-forward relaying in cognitive radio networks," in *Proc. IEEE Int. Conf. Acoust. Speech Signal Process. (ICASSP)*, 2016, pp. 3636–3640.
- [222] H. Kim, S. Lim, H. Wang, and D. Hong, "Optimal power allocation and outage analysis for cognitive full duplex relay systems," *IEEE Trans. Wireless Commun.*, vol. 11, no. 10, pp. 3754–3765, Oct. 2012.
- [223] I. Hwang, B. Song, C. Nguyen, and S. S. Soliman, "Digitally controlled analog wideband interference cancellation for in-device spectrum sharing and aggregation," *IEEE J. Sel. Areas Commun.*, vol. 34, no. 11, pp. 2838–2850, Nov. 2016.
- [224] H. Wu *et al.*, "GRT-duplex: A novel SDR platform for full-duplex WiFi," *Mobile Netw. Appl.*, vol. 21, no. 6, pp. 983–993, 2016.
- [225] P. Vijayakumar and S. Malarvizhi, "Wide band full duplex spectrum sensing with self-interference cancellation—An efficient SDR implementation," *Mobile Netw. Appl.*, to be published.
- [226] S. H. Chae, S.-W. Jeon, and S. H. Lim, "Fundamental limits of spectrum sharing full-duplex multicell networks," *IEEE J. Sel. Areas Commun.*, vol. 34, no. 11, pp. 3048–3061, Nov. 2016.
- [227] F. Aurzada, M. Lévesque, M. Maier, and M. Reisslein, "FiWi access networks based on next-generation PON and gigabit-class WLAN technologies: A capacity and delay analysis," *IEEE/ACM Trans. Netw.*, vol. 22, no. 4, pp. 1176–1189, Aug. 2014.
- [228] A. G. Sarigiannidis *et al.*, "Architectures and bandwidth allocation schemes for hybrid wireless-optical networks," *IEEE Commun. Surveys Tuts.*, vol. 17, no. 1, pp. 427–468, 1st Quart., 2015.
- [229] J. A. Arokiam, K. N. Brown, and C. J. Sreenan, "Optimised QoS-aware DBA mechanisms in XG-PON for upstream traffic in LTE backhaul," in *Proc. IEEE Int. Conf. Future Internet Things Cloud Workshops (FiCloudW)*, Vienna, Austria, Aug. 2016, pp. 361–368.
- [230] B. Kantarci and H. T. Mouftah, "Bandwidth distribution solutions for performance enhancement in long-reach passive optical networks," *IEEE Commun. Surveys Tuts.*, vol. 14, no. 3, pp. 714–733, 3rd Quart., 2012.
- [231] A. Mercian, M. P. McGarry, and M. Reisslein, "Offline and online multi-thread polling in long-reach PONs: A critical evaluation," *IEEE/OSA J. Lightw. Technol.*, vol. 31, no. 12, pp. 2018–2028, Jun. 15, 2013.
- [232] M. Xu, X. Liu, N. Chand, F. Effenberger, and G.-K. Chang, "Flex-frame timing-critical passive optical networks for delay sensitive mobile and fixed access services," in *Proc. OSA Opt. Fiber Commun. Conf.*, 2017, pp. 1–3.
- [233] S. Zhou, X. Liu, F. Effenberger, and J. Chao, "Mobile-PON: A high-efficiency low-latency mobile fronthaul based on functional split and TDM-PON with a unified scheduler," in *Proc. OSA Opt. Fiber Commun. Conf.*, 2017, pp. 1–3.

- [234] Z. Alharbi, A. Thyagaturu, M. Reisslein, H. ElBakoury, and R. Zheng, "Performance comparison of R-PHY and R-MACPHY modular cable access network architectures," *IEEE Trans. Broadcast.*, to be published.
- [235] P. Bhaumik *et al.*, "EPON protocol over coax (EPOC): Overview and design issues from a MAC layer perspective?" *IEEE Commun. Mag.*, vol. 51, no. 10, pp. 144–153, Oct. 2013.
- [236] E. I. Gurrola, M. P. McGarry, Y. Luo, and F. Effenberger, "PON/xDSL hybrid access networks," *Opt. Switching Netw.*, vol. 14, pp. 32–42, Aug. 2014.
- [237] A. Mercian, E. I. Gurrola, F. Aurzada, M. P. McGarry, and M. Reisslein, "Upstream polling protocols for flow control in PON/xDSL hybrid access networks," *IEEE Trans. Commun.*, vol. 64, no. 7, pp. 2971–2984, Jul. 2016.
- [238] A. Ahmed and A. Shami, "RPR-EPON-WiMAX hybrid network: A solution for access and metro networks," *IEEE/OSA J. Opt. Commun. Netw.*, vol. 4, no. 3, pp. 173–188, Mar. 2012.
- [239] I.-F. Chao and M. C. Yuang, "Toward wireless backhaul using circuit emulation over optical packet-switched metro WDM ring network," *IEEE/OSA J. Lightw. Technol.*, vol. 31, no. 18, pp. 3032–3042, Sep. 15, 2013.
- [240] K. Kondepudi, A. Sgambelluri, L. Valcarenghi, F. Cugini, and P. Castoldi, "An SDN-based integration of green TWDM-PONs and metro networks preserving end-to-end delay," in *Proc. IEEE/OSA Opt. Fiber Commun. Conf. Exhibit. (OFC)*, 2015, pp. 1–3.
- [241] M. Maier, M. Reisslein, and A. Wolisz, "A hybrid MAC protocol for a metro WDM network using multiple free spectral ranges of an arrayed-waveguide grating," *Comput. Netw.*, vol. 41, no. 4, pp. 407–433, 2003.
- [242] H.-S. Yang, M. Maier, M. Reisslein, and W. M. Carlyle, "A genetic algorithm-based methodology for optimizing multiservice convergence in a metro WDM network," *IEEE/OSA J. Lightw. Technol.*, vol. 21, no. 5, pp. 1114–1133, May 2003.
- [243] R. F. E. Khatib and H. B. Salameh, "A routing scheme for cognitive radio networks with self-interference suppression capabilities," in *Proc. IEEE Int. Conf. Softw. Defined Syst. (SDS)*, May 2017, pp. 20–25.
- [244] B. Canberk, I. F. Akyildiz, and S. Oktug, "Primary user activity modeling using first-difference filter clustering and correlation in cognitive radio networks," *IEEE/ACM Trans. Netw.*, vol. 19, no. 1, pp. 170–183, Feb. 2011.
- [245] H. Liu, K. J. Kim, K. S. Kwak, and H. V. Poor, "Power splitting-based SWIPT with decode-and-forward full-duplex relaying," *IEEE Trans. Wireless Commun.*, vol. 15, no. 11, pp. 7561–7577, Nov. 2016.
- [246] S. H. R. Bukhari, M. H. Rehmani, and S. Siraj, "A survey of channel bonding for wireless networks and guidelines of channel bonding for futuristic cognitive radio sensor networks," *IEEE Commun. Surveys Tuts.*, vol. 18, no. 2, pp. 924–948, 2nd Quart., 2016.
- [247] A. Celik, A. Alsharoa, and A. E. Kamal, "Hybrid energy harvesting-based cooperative spectrum sensing and access in heterogeneous cognitive radio networks," *IEEE Trans. Cogn. Commun. Netw.*, vol. 3, no. 1, pp. 37–48, Mar. 2017.
- [248] H. Xing, X. Kang, K.-K. Wong, and A. Nallanathan, "Optimizing DF cognitive radio networks with full-duplex-enabled energy access points," *IEEE Trans. Wireless Commun.*, to be published.
- [249] R. Zhang, H. Chen, P. L. Yeoh, Y. Li, and B. Vucetic, "Full-duplex cooperative cognitive radio networks with wireless energy harvesting," *arXiv preprint arXiv:1703.06596*, 2017.
- [250] R. Mahapatra, Y. Nijssure, G. Kaddoum, N. U. Hassan, and C. Yuen, "Energy efficiency tradeoff mechanism towards wireless green communication: A survey," *IEEE Commun. Surveys Tuts.*, vol. 18, no. 1, pp. 686–705, 1st Quart., 2016.
- [251] C. Guo, F. Liu, S. Chen, C. Feng, and Z. Zeng, "Advances on exploiting polarization in wireless communications: Channels, technologies, and applications," *IEEE Commun. Surveys Tuts.*, vol. 19, no. 1, pp. 125–166, 1st Quart., 2017.
- [252] F. Liu, S. Jia, C. Guo, and C. Feng, "Exploiting polarization to resist phase noise for digital self-interference cancellation in full-duplex," in *Proc. IEEE Int. Conf. Commun. (ICC)*, Kuala Lumpur, Malaysia, 2016, pp. 1–6.
- [253] S. Kam, D. Kim, H. Lee, and D. Hong, "Bidirectional full-duplex systems in a multispectrum environment," *IEEE Trans. Veh. Technol.*, vol. 64, no. 8, pp. 3812–3817, Aug. 2015.
- [254] D. Guo and L. Zhang, "Virtual full-duplex wireless communication via rapid on-off-division duplex," in *Proc. IEEE Annu. Allerton Conf. Commun. Control Comput.*, Monticello, IL, USA, 2010, pp. 412–419.
- [255] S. M. Kim and M. Bengtsson, "Virtual full-duplex buffer-aided relaying—Relay selection and beamforming," in *Proc. IEEE Int. Symp. Pers. Indoor Mobile Radio Commun. (PIMRC)*, 2013, pp. 1748–1752.
- [256] L. Zhang and D. Guo, "Virtual full duplex wireless broadcasting via compressed sensing," *IEEE/ACM Trans. Netw.*, vol. 22, no. 5, pp. 1659–1671, Oct. 2014.
- [257] M. Z. Farooqi, S. M. Tabassum, M. H. Rehmani, and Y. Saleem, "A survey on network coding: From traditional wireless networks to emerging cognitive radio networks," *J. Netw. Comput. Appl.*, vol. 46, pp. 166–181, Nov. 2014.
- [258] A. Naeem, M. H. Rehmani, Y. Saleem, I. Rashid, and N. Crespi, "Network coding in cognitive radio networks: A comprehensive survey," *IEEE Commun. Surveys Tuts.*, to be published.
- [259] R. Bassoli, H. Marques, J. Rodriguez, K. W. Shum, and R. Tafazolli, "Network coding theory: A survey," *IEEE Commun. Surveys Tuts.*, vol. 15, no. 4, pp. 1950–1978, 4th Quart., 2013.
- [260] A. Douik, S. Sorour, T. Y. Al-Naffouri, and M.-S. Alouini, "Instantly decodable network coding: From centralized to device-to-device communications," *IEEE Commun. Surveys Tuts.*, vol. 19, no. 2, pp. 1201–1224, 2nd Quart., 2017.
- [261] T. Ho *et al.*, "A random linear network coding approach to multicast," *IEEE Trans. Inf. Theory*, vol. 52, no. 10, pp. 4413–4430, Oct. 2006.
- [262] M. V. Pedersen, J. Heide, and F. H. P. Fitzek, "Kodo: An open and research oriented network coding library," in *Proc. Int. Conf. Res. Netw.*, vol. 6827, 2011, pp. 145–152.
- [263] S. T. Basaran, G. K. Kurt, M. Uysal, and I. Altunbaş, "A tutorial on network coded cooperation," *IEEE Commun. Surveys Tuts.*, vol. 18, no. 4, pp. 2970–2990, 4th Quart., 2016.
- [264] J. Widmer and J.-Y. Le Boudec, "Network coding for efficient communication in extreme networks," in *Proc. ACM SIGCOMM Workshop Delay Tolerant Netw.*, Philadelphia, PA, USA, 2005, pp. 284–291.
- [265] S. Wunderlich, J. Cabrera, F. Fitzek, and M. Reisslein, "Network coding in heterogeneous multicore IoT nodes with DAG scheduling of parallel matrix block operations," *IEEE Internet Things J.*, to be published.
- [266] R. Kumbhkar, G. Sridharan, N. B. Mandayam, I. Seskar, and S. Kompella, "Design and implementation of an underlay control channel for NC-OFDM-based networks," in *Proc. Conf. Inf. Sci. Syst. (CISS)*, Princeton, NJ, USA, 2016, pp. 228–233.
- [267] A. Blenk, A. Basta, M. Reisslein, and W. Kellerer, "Survey on network virtualization hypervisors for software defined networking," *IEEE Commun. Surveys Tuts.*, vol. 18, no. 1, pp. 655–685, 1st Quart., 2016.
- [268] A. Blenk, A. Basta, J. Zerwas, M. Reisslein, and W. Kellerer, "Control plane latency with SDN network hypervisors: The cost of virtualization," *IEEE Trans. Netw. Service Manag.*, vol. 13, no. 3, pp. 366–380, Sep. 2016.
- [269] C. Liang and F. R. Yu, "Wireless network virtualization: A survey, some research issues and challenges," *IEEE Commun. Surveys Tuts.*, vol. 17, no. 1, pp. 358–380, 1st Quart., 2015.
- [270] R. Mijumbi *et al.*, "Network function virtualization: State-of-the-art and research challenges," *IEEE Commun. Surveys Tuts.*, vol. 18, no. 1, pp. 236–262, 1st Quart., 2016.
- [271] Y. Jararweh *et al.*, "Software defined cognitive radio network framework: Design and evaluation," *Int. J. Grid High Perform. Comput.*, vol. 7, no. 1, pp. 15–31, 2015.
- [272] K. Nakauchi, K. Ishizu, H. Murakami, A. Nakao, and H. Harada, "AMPHIBIA: A cognitive virtualization platform for end-to-end slicing," in *Proc. IEEE ICC*, 2011, pp. 1–5.
- [273] S. Namal, I. Ahmad, S. Saud, M. Jokinen, and A. Gurtov, "Implementation of OpenFlow based cognitive radio network architecture: SDN&R," *Wireless Netw.*, vol. 22, no. 2, pp. 663–677, 2016.
- [274] R. Alvizu *et al.*, "Comprehensive survey on T-SDN: Software-defined networking for transport networks," *IEEE Commun. Surveys Tuts.*, to be published.
- [275] I. T. Haque and N. Abu-Ghazaleh, "Wireless software defined networking: A survey and taxonomy," *IEEE Commun. Surveys Tuts.*, vol. 18, no. 4, pp. 2713–2737, 4th Quart., 2016.
- [276] T. Huang *et al.*, "A survey on large-scale software defined networking (SDN) testbeds: Approaches and challenges," *IEEE Commun. Surveys Tuts.*, vol. 19, no. 2, pp. 891–917, 2nd Quart., 2017.
- [277] A. Mendiola, J. Astorga, E. Jacob, and M. Higuero, "A survey on the contributions of software-defined networking to traffic engineering," *IEEE Commun. Surveys Tuts.*, vol. 19, no. 2, pp. 918–953, 2nd Quart., 2017.
- [278] V. G. Nguyen, A. Brunstrom, K.-J. Grinnemo, and J. Taheri, "SDN/NFV-based mobile packet core network architectures: A survey," *IEEE Commun. Surveys Tuts.*, to be published.

- [279] D. B. Rawat and S. R. Reddy, "Software defined networking architecture, security and energy efficiency: A survey," *IEEE Commun. Surveys Tuts.*, vol. 19, no. 1, pp. 325–346, 1st Quart., 2017.
- [280] A. S. Thyagaturu, A. Mercian, M. P. McGarry, M. Reisslein, and W. Kellerer, "Software defined optical networks (SDONs): A comprehensive survey," *IEEE Commun. Surveys Tuts.*, vol. 18, no. 4, pp. 2738–2786, 4th Quart., 2016.
- [281] C. Trois, M. D. D. Fabro, L. C. E. de Bona, and M. Martinello, "A survey on SDN programming languages: Toward a taxonomy," *IEEE Commun. Surveys Tuts.*, vol. 18, no. 4, pp. 2687–2712, 4th Quart., 2016.



Muhammad Amjad received the B.S. degree in telecommunication systems from Bahauddin Zakariya University, Multan, Pakistan, in 2011, and the M.S. degree in computer science from the COMSATS Institute of Information Technology, Islamabad, Pakistan, in 2016. His research interests include cognitive radio networks, wireless sensor networks, vehicular ad-hoc networks, and electrical vehicles. He was a recipient of the Best Paper Award from the ACM 7th International Conference on Computing Communication and Networking

Technologies, USA, in 2016, and the Best Reviewer of the Year Award from *Computers and Electrical Engineering Journal* in 2016.



Fayaz Akhtar received the M.S. degree in electrical engineering from the COMSATS Institute of Information Technology, Wah Cantt, Pakistan. He is currently a Postgraduate Researcher with the Telecommunications Software and Systems Group, Waterford Institute of Technology, Ireland. His research interests include software-defined networking, network function virtualization, energy harvesting in miniature devices, cognitive radio networks, and the Internet of Things.



Mubashir Husain Rehmani (M'14–SM'15) received the B.Eng. degree in computer systems engineering from the Mehran University of Engineering and Technology, Jamshoro, Pakistan, in 2004; the M.S. degree from the University of Paris XI, Paris, France, in 2008; and the Ph.D. degree from the University Pierre and Marie Curie, Paris, in 2011. He is currently an Assistant Professor with the COMSATS Institute of Information Technology, Wah Cantt, Pakistan. He was a Post-Doctoral Fellow at the University

of Paris Est, France, in 2012. He has authored/edited two books published by IGI Global, USA; one book published by CRC Press, USA; and one book is in progress with Wiley, U.K. His current research interests include cognitive radio ad hoc networks, smart grid, wireless sensor networks, and mobile ad hoc networks. He was a recipient of the Best Researcher of the Year of COMSATS Wah Award in 2015, and the Best Paper Award from the IEEE Communications Society Technical Committee on Communications Systems Integration and Modeling at IEEE ICC 2017, Paris. He received the Certificate of Appreciation Exemplary Editor of the IEEE Communications Surveys and Tutorials in 2015 from the IEEE Communications Society. He served as a TPC for IEEE ICC 2016, IEEE GlobeCom 2016, CROWCOM 2016, IEEE VTC Spring 2016, IEEE ICC 2015, IEEE WoWMoM 2014, IEEE ICC 2014, ACM CoNEXT Student Workshop 2013, IEEE ICC 2013, and IEEE IWCMC 2013. He is currently an Editor of the IEEE COMMUNICATIONS SURVEYS AND TUTORIALS and an Associate Editor of the *IEEE Communications Magazine*, *IEEE ACCESS Computers and Electrical Engineering*, the *Journal of Network and Computer Applications*, *FGCS*, *Ad Hoc Sensor Wireless Networks*, *Wireless Networks*, *KSII Transactions on Internet and Information Systems*, and the *Journal of Communications and Networks*. He is also serving as a Guest Editor of *Ad Hoc Networks*, *Future Generation Computer Systems*, *IEEE ACCESS*, the IEEE TRANSACTIONS ON INDUSTRIAL INFORMATICS, *Pervasive and Mobile Computing*, and *Computers and Electrical Engineering*. He is the Founding Member of IEEE Special Interest Group on Green and Sustainable Networking and Computing with Cognition and Cooperation.



Martin Reisslein (A'96–S'97–M'98–SM'03–F'14) received the Ph.D. degree in systems engineering from the University of Pennsylvania, in 1998. He is a Professor with the School of Electrical, Computer, and Energy Engineering, Arizona State University, Tempe. He currently serves as an Associate Editor for the IEEE TRANSACTIONS ON MOBILE COMPUTING, the IEEE TRANSACTIONS ON EDUCATION, IEEE ACCESS, *Computer Networks*, and *Optical Switching and Networking*.

He is an Associate Editor-in-Chief for the IEEE COMMUNICATIONS SURVEYS AND TUTORIALS and chairs the steering committee of the IEEE TRANSACTIONS ON MULTIMEDIA.



Tariq Umer (M'16–SM'16) received the Ph.D. degree in communication systems from the School of Computing and Communication, Lancaster University, U.K., in 2012, and the master's degree in computer science from Bahauddin Zakariya University, Multan, Pakistan, in 1997. He served for the IT education sector in Pakistan for over 13 years. Since 2007, he has been an Assistant Professor with the CS Department, COMSATS Institute of Information Technology, Wah Cantt. His research interests include cognitive radio ad hoc networks,

Internet of Things, wireless sensor networks, telecommunication network design, vehicular adhoc networks, and Internet of Vehicles. He is currently serving as an Editorial Board Member of *Future Generation Computer System* and as an Associate Editor of the IEEE ACCESS. He served as a TPC for the international conference FIT 15, 16, IEEE PGnet 2011, 2012, and IEEE FMEC 2016. He is currently serving as a Reviewer for IEEE COMMUNICATIONS LETTERS, IEEE ACCESS, *Computers and Electrical Engineering*, the *Journal of Network and Computer Applications*, *Wireless Networks*, and the *Journal of Communications and Networks*. He is also serving as a Guest Editor of *Future Generation Computer Systems* and IEEE ACCESS. He is the Active Member of the Pakistan Computer Society and the Internet Society Pakistan.